

## SUPERBOOM SL-850RfII ラフター KR-80H-F (SLジブ) PREMIUM Rougher

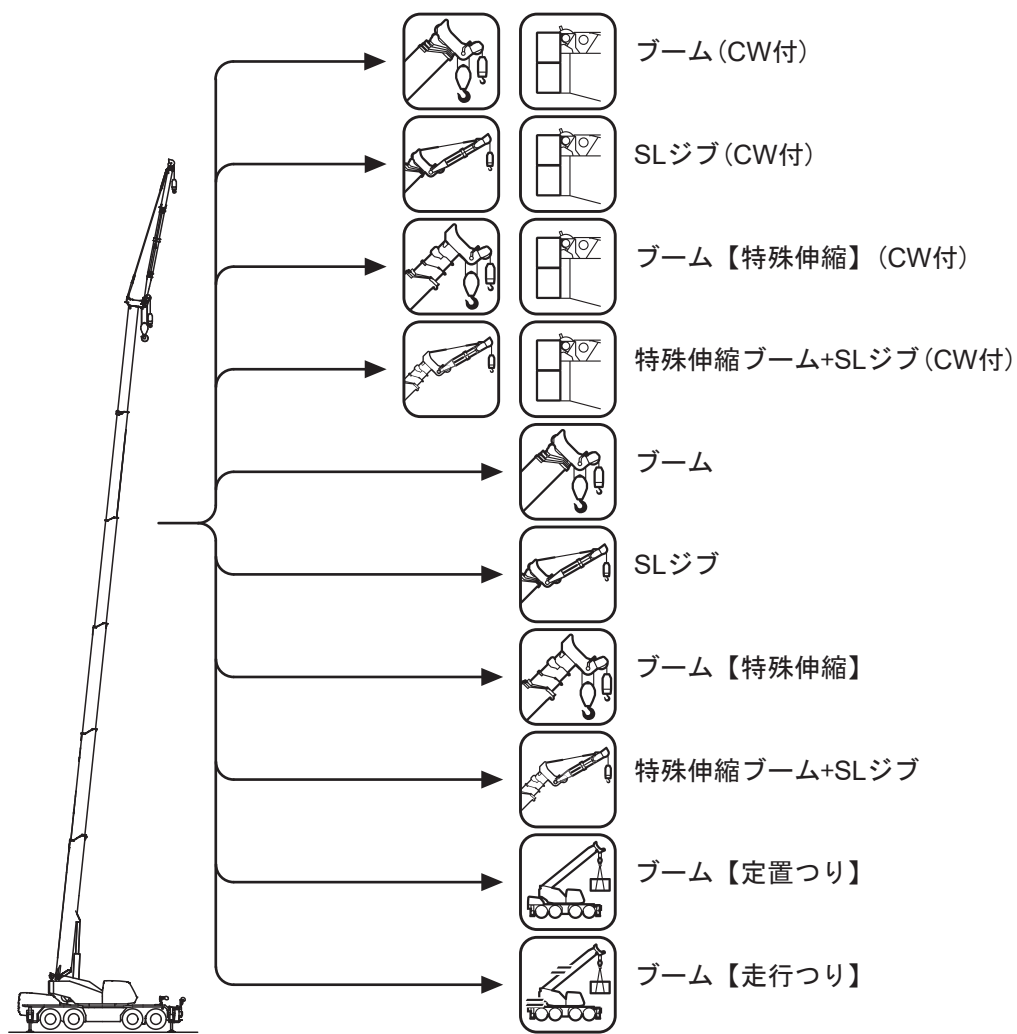

### 目次

主要諸元	3
定格総荷重表注意事項	4
作業範囲図	7
定格総荷重表	
ブーム【通常伸縮・特殊伸縮】	8
ブーム+SLジブ	26
最小通路軌跡図	45
全体図	46
全体図	47



# ■主要諸元

## ■クレーン部

名 称	80ton吊りラフテレーンクレーン
型 式	KR-80H-F

## ●クレーン性能

最大定格総荷重	10.0mブーム	80,000kg× 2.2m (20本掛) (前方左右各15°合計30°の旋回範囲のみ)
	13.0mブーム	40,000kg× 5.5m (10本掛)
	17.0mブーム	40,000kg× 4.5m (10本掛)
	20.0mブーム	38,000kg× 3.5m (10本掛)
	24.0mブーム	35,000kg× 3.5m (7本掛)
	31.0mブーム	14,000kg× 10.0m (4本掛)
	38.0mブーム	13,000kg× 9.0m (4本掛)
	42.0mブーム	10,200kg× 12.0m (4本掛)
	45.0mブーム	8,200kg× 13.0m (4本掛)
		9.52mジブ
	13.8mジブ	2,800kg (1本掛)
	18.0mジブ	1,800kg (1本掛)
	ルースタシブ	5,600kg (1本掛)
ブーム長さ	10.0m ~ 45.0m	
ジブ長さ	9.52m ~ 18.0m	
最大地上揚程	46.0m (ブーム) 64.0m (ジブ)	
巻上ロープ速度	主巻	130m / min (5層目)
	補巻	120m / min (4層目)
巻上フック速度	主フック	(ロープ掛数 20) 6.0m / min (4層目)
	補フック	(ロープ掛数 1) 120.0m / min (4層目)
ブーム起伏範囲	0°~84°	
ブーム上げ時間	63s / 0°~84°	
ブーム伸長速度	35m / 125s	
旋 回 速 度	1.8min <sup>-1</sup>	
旋 回 後 端 半 径	3,550mm (カウンタウエイト無)	
	3,900mm (カウンタウエイト付)	

## ●上部旋回体の装置および構造

ブーム形式	箱型6段油圧伸縮式 (2・3段同時、4・5・6段同時)	
ジブ形式	3段油圧伸縮式 (2・3段同時) 油圧無段傾斜式 (オフセット5°~60°)	
ブーム伸縮装置	油圧シリンダ (2本) およびロックピン、ワイヤロープ併用	
ブーム起伏装置	油圧シリンダ直挿式 (2本)、圧力補償付流量調整弁付	
ジブ伸縮装置	油圧シリンダ (1本) およびワイヤロープ併用	
ジブ起伏装置	油圧シリンダ (2本)	
巻上装置	シンクルインチ2基、油圧モータ駆動・遊星歯車減速式 (ネガティブブレーキ内蔵) 自動ブレーキ付、圧力補償付流量調整弁付	
旋回装置	油圧モータ駆動・遊星歯車減速機付 (ネガティブブレーキ内蔵) ブリー・ロック切換式、高低速切換式	
旋回サークル	ボールベアリング式	
アウトリガ装置	形式	全油圧H型 (フロート、パーチカルシリンダ一体型)
	張出幅	7,600mm (最大張出)
		7,200mm (中間張出)
		6,500mm (中間張出)
		5,400mm (中間張出)
		4,300mm (中間張出)
2,550mm (最縮小張出)		
ワイヤロープ	主巻	難回転性ワイヤロープ φ18 × 255m
	補巻	難回転性ワイヤロープ φ18 × 135m

## ●油圧装置

油圧ポンプ	2連可変プランジャ型、2連可変プランジャ型	
油圧モータ	巻上用	アキシャルプランジャ型
	旋回用	アキシャルプランジャ型
コントロールバルブ	マルチプル自動復元式 (圧力補償付流量調整弁付)	
シリンダー	ダブルアクティング式	
オイルリザーバ容量	690L	

## ●安全装置

ACS (過負荷防止装置・音声警報装置付)、旋回自動停止装置、ブーム起伏緩停止装置、ブーム伸長緩停止装置、作業範囲制限装置、アウトリガ張出幅自動検出装置、ブーム起伏自然降下防止装置、ブーム伸縮自然降下防止装置、ジブ起伏自然降下防止装置、ジブ伸縮自然降下防止装置、過巻防止装置、ドラムホールド安全装置、自動ブレーキ装置、乱巻防止装置、油圧安全弁、アウトリガロック装置、旋回ロック装置、旋回警告灯、作動油オーバーヒート警報装置、作動油フィルタ目づまり警報装置、玉倒りロープはざれ止め
---

## ●標準装置

ドラム回転指示装置、オイルクーラ、ACS外部表示装置、ACS外部音声警報装置、拡声器、ウインチ確認カメラ、リモコンサーチライト、LED作業灯 (ブーム、テーブル、キャブ) カメラクリーナ (ウインチカメラ確認用)
--

## ●キャブ装備

除湿機能付エアコン、液封式キャブマウント、チルト/テレスコピックハンドル、アラジャスタブル・サスペンションシート (ヘッドレスト、アームレスト付)、パワーウィンドウ (閉め忘れ防止スイッチ付)、間欠付フロント&ルーフワイパー (ウオッシャー付)、Bluetooth付AM/FMラジオ、フロアマット、デジタルコグラフ、エントリーキーシステム、シフトスイッチ、クレーン作業記録装置 (注1)、電子水準器 (自動アウトリガ水平補助機能付)、LEDルームランプ、LEDステップランプ、アクセサリソケット (24V)、USB電源装置 (注1) オプションのICカードシステム選付時は装置不可。
---

## ●オプション装置

地上デジタル対応テレビ放送受信装置、燃焼式エアヒータ、ドアバイザ、風速計、消火器、大型ランチテーブル、ICカードシステム (クレーン作業・走行データ記録用)、ICカードリーダー&データ管理ソフト、ハンズフリーマイク、
--

●Bluetooth®はBluetooth SIG, Inc.の登録商標です。

## ■キャリア部

### ●走行性能

最 高 速 度	49km / h
登 坂 能 力	0.59 (tanθ)
最 小 回 転 半 径	11.8m (4輪偏向)
	7.4m (8輪偏向)

### ●エンジン

エ ン ジ ン 名 称	日野 E13C-YS (インタークーラターボ付) (平成26年ディーゼル特殊自動車排出ガス規制適合)
エ ン ジ ン 形 式	水冷4サイクル6気筒 直接噴射式ディーゼルエンジン
総 排 気 量	12.913L
最 高 出 力	275kW / 1,800min <sup>-1</sup>
最 大 ト ル ク	1,510N・m / 1,300min <sup>-1</sup>

### ●下部走行体の装置および構造

走 行 駆 動 形 式	4輪駆動 (8×4)・6輪駆動 (8×6) 切換式	
トルクコンバータ形式	3要素 1段 (自動ロックアップクラッチ付)	
変 速 機 形 式	全自動および手動変速式	
変 速 段 数	前進6段 後退2段	
車 軸 形 式	前前輪	全浮動軸管式逆エリオット形 (ドライブステア、減速機、テフロック付)
	前後輪	全浮動軸管式逆エリオット形 (ドライブステア、減速機、インターアクスルフロック、テフロック付)
	後前輪	逆エリオット形 (ステア)
	後後輪	全浮動軸管式逆エリオット形 (ドライブステア、減速機、テフロック付)
懸 架 装 置	前前輪	ハイドロニューマチックサスペンション (油圧ロックシリンダー付)
	前後輪	ハイドロニューマチックサスペンション (油圧ロックシリンダー付)
	後前輪	ハイドロニューマチックサスペンション (油圧ロックシリンダー付)
	後後輪	ハイドロニューマチックサスペンション (油圧ロックシリンダー付)
ブ レ ー キ 装 置	主	2系統空気油圧複合式 全輪ディスクブレーキ
	補助	空気・推進軸制動内部拡張形 原動機排気弁油圧作動式リターダ (電子制御によるトルクロックアップ同時制御方式) 流体式リターダ、作業用補助制動装置
ス テ ア リ ン グ 装 置	形式	全油圧式パワーステアリング
	モード	前4輪、カウンタ、クラブ、後4輪、前後輪独立 (5モード) (リヤステ自動ロック機構付)
タ イ ヤ サ イ ズ	前 輪	385 / 95 R25 170E ROAD
	後 輪	385 / 95 R25 170E ROAD
燃 料 タ ン ク 容 量	370L	
バ ッ テ リ	(12V-170AH) × 2	

### ●安全装置

緊急用かじり装置、後輪ステアリングロック装置、ブレーキ液漏警報装置、作業用補助制動装置、サスペンションロック装置、オーバーラン警報装置、ラジエータ液面警報装置、エアフィルタ目づまり警報装置、ローアワー警報装置、電動格納サイドミラー、左方確認カメラ、右方確認カメラ、左前方確認カメラ、右後方確認カメラおよび12インチ大型タッチモニター (人検知支援機能付)、セーフティビュースystem、クリアランスソナースystem (左前部、左前輪部、左後角部、右後角部および最後部検出)、前方確認カメラ
---

### ●標準装置

フルLEDヘッドランプ (アクセラライト付)、バイパスフィルター、アルミ敷板、車輪止め、踏肩灯、LEDサイドマーカーランプ (アンダーライト付)、カメラクリーナ (セーフティビューカメラ用)、カメラクリーナ (左方確認カメラ、右方確認カメラ用)
--

### ●オプション装置

ヒータ付サイドミラー、ブーム右側ミラー、左折およびバック音声警報装置、タイヤ空気圧モニタリングシステム、アウトリガ操作ラジコン
---

## ■寸法・重量

全 長	13,260mm	
全 幅	2,850mm	
全 高	3,750mm	
軸 距	1,550+3,900+1,550=7,000mm	
輪 距	前 輪	2,390mm
	後 輪	2,390mm
乗 車 定 員	1人	
車 両 総 重 量	全重量	41,155kg
	前輪重	10,230kg
	前後輪重	10,370kg
	後前輪重	10,215kg
	後後輪重	10,340kg
	カウンタウエイト重	41,155kg
作 業 時 総 重 量	カウンタウエイト重	46,155kg

1. 本機は、カウンタウエイトを装着したままでは公道を走行することはできません。構内を移動する場合に限り、カウンタウエイトを装着したままでも走行できますが、走行速度は15km/h以下に制限されます。
2. 本機は、新規開発車両証明制度による適合証明書「基本通行条件 重量：D」の交付を受けていますが、実際の通行条件は、運行経路ごとの道路管理者の算定結果によって付与されます。

## ■運転および作業に必要な資格

 <b>注意事項</b>	クレーンの運転	移動式クレーン運転士免許
	玉掛作業	玉掛技能講習
	車両の運転	大型特殊自動車運転免許

- 走行時はフックを所定の位置に格納してください。
- 道路の走行には、道路法による通行の許可と道路運送車両法による保安基準の緩和が必要です。
- 本車両は最低速度 (50km/h) の定めのある「高速自動車国道」を走行することはできません。
- 本機の使用にあたっての注意事項は、取扱説明書をよく読んで正しくお使いください。
- 本カタログに記載されておりませんが性能並びに仕様は、改良などによりお届けいたします製品と異なる場合があります。また、仕様は予告なく変更することがありますのであらかじめご了承ください。

13A000000

## ■ 定格総荷重表注意事項

### ● アウトリガ使用時

1. 定格総荷重表は水平堅土上において機体を水平に設置し、ブームのロックピンが連結された状態での保証できる最大荷重を示しており、ブーム作業時は主フックとつり具、SLジブ作業時は補フックとつり具の質量を含んだ値です。

なお、ロックピンが解除された状態での定格総荷重は、最大11tonに制限されます。

【80tフック (質量830kg)、40tフック (質量470kg)、35tフック (質量330kg)、5.6tフック (質量120kg)】

□部分は機械の強度によって、他は機体の安定度によって定められています。

2. 作業半径はブーム、SLジブのたわみを含んだ実際の値にもとづいていますので、必ず作業半径を基準として作業を行ってください。
3. SLジブの作業半径は45m、24mまたは31m (特殊伸縮) ブームにSLジブを装着して作業を行った場合の値です。通常伸縮ブーム状態において24.0mをこえ45.0m未満のブーム長さでSLジブ作業を行う場合は、45.0mブームの角度を基準としてください。通常伸縮ブーム状態において24.0m未満のブーム長さでSLジブ作業を行う場合は、24.0mブームの角度を基準としてください。特殊伸縮ブーム状態において31.0m未満のブーム長さでSLジブ作業を行う場合は、31.0mブームの角度を基準としてください。
4. アウトリガ最縮小張出では、SLジブ作業およびカウンタウエイトを装着した作業を行わないでください。
5. アウトリガ張出状態によって側方領域でのつり上性能は異なります。従って各々の張出状態における定格総荷重表で作業を行ってください。

また、前方領域でのつり上性能は前方性能の定格総荷重表で、後方領域でのつり上性能はアウトリガ最大張出の定格総荷重表でそれぞれ作業を行ってください。

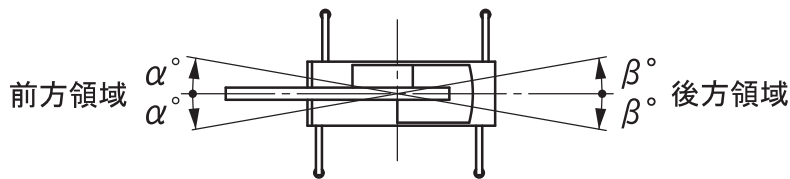

領域 α°			前側アウトリガ張出状態					
			最大張出	中間張出				最縮小張出※
			7.6m	7.2m	6.5m	5.4m	4.3m	2.55m
張出状態 後側 アウトリガ	最大張出	7.6m	45	30	25	15	10	3
	中間張出	7.2m						
		6.5m						
		5.4m						
		4.3m						
最縮小張出※	2.55m	30						

領域 β°			前側アウトリガ張出状態					
			最大張出	中間張出				最縮小張出※
			7.6m	7.2m	6.5m	5.4m	4.3m	2.55m
張出状態 後側 アウトリガ	最大張出	7.6m	30					
	中間張出	7.2m	30					
		6.5m	25					
		5.4m	25					
		4.3m	15					
	最縮小張出※	2.55m	3					

※SLジブ作業時およびカウンタウエイト装着時は作業できません。

6. ルースタシーブの定格総荷重は、ブームの定格総荷重よりブームに取付けられているフックその他のつり具の質量を差引いた値とし、かつ限度を下記のとおりとします。

通常伸縮	特殊伸縮
10～38mブーム : 5600kg	10～24mブーム : 5600kg
42mブーム : 5300kg	31mブーム : 5000kg
45mブーム : 5000kg	

【ルースタシーブ使用フック : 5.6tフック (質量120kg) 巻掛本数1】

7. ブーム長さ、ブーム角度、作業半径、SLジブ長さおよび角度が規定の値をこえる場合にはその規定の値と、次の規定の値の定格総荷重のうち小さい方の定格総荷重を目安として作業を行ってください。
8. SLジブを装着したままでブーム作業を行う場合の定格総荷重は、ブームの定格総荷重よりフックその他のつり具等の質量の他に4,500kgを差引いた値とし、かつ上限を18tonとします。  
SLジブの姿勢はジブ長さ9.52mジブ角度5°としてください。  
なお、SLジブを装着したままでのルースタシーブ作業、およびアウトリガ最縮小張出におけるSLジブを装着したままでのブーム作業は行わないでください。
9. 各々の作業状態におけるブーム危険角度は表のとおりです。ブームを危険角度以下にしますと無負荷でも転倒しますので充分注意してください。
10. 各ブーム長さに対する標準フック巻掛本数は表のとおりです。ただし標準巻掛本数以外の掛数で使用する場合は、ワイヤロープ1本当たり45.1kN (4.6tf) を限度としてください。
11. フック巻掛本数20本で作業を行う場合はルースタシーブを使用してください。
12. 高速巻下作業は、フックのみを降下するときに使用してください。また急激なレバー操作はさけてください。
13. クレーン作業は風速10m/sまで可能ですが、比較的弱い風の場合でも受風面積の大きい荷重を取扱う場合は特別な注意を払ってください。
14. 定格総荷重をこえる作業を行った場合、および正しい使い方を行わなかった場合は転倒または破損します。この場合本機の保証はいたしません。

●アウトリガ不使用時

1. 定格総荷重表は、水平堅土上においてタイヤの空気圧が規定圧で、かつサスペンションシリンダを「レベルロック」した場合に本機の保証できる最大荷重を示しており、主フックとつり具の質量を含んだ値です。

□部分は機械の強度によって、他は機体の安定度によって定められています。

【タイヤ規定空気圧：900kPa】

2. 作業半径はブームのたわみを含んだ実際の値にもとづいていますので、必ず作業半径を基準として作業を行ってください。
3. 前方性能と全周性能とでは定格総荷重が異なります。前方領域から側方領域へ旋回する場合には過荷重になるおそれがありますので充分注意してください。

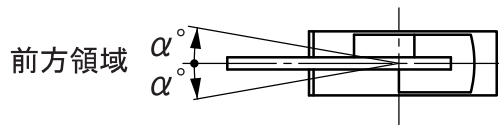

クレーン作業領域 α°	定置つり	走行つり
	1	1

4. ルースタシーブの定格総荷重は、ブームの定格総荷重よりブームに取付けられているフックその他のつり具の質量を差引いた値とし、かつ限度を5,600kgとします。  
【ルースタシーブ使用フック：5.6tフック（質量120kg） 巻掛本数1】
5. ブームは特殊伸縮状態とし、ブーム長さ17.0mをこえるブーム作業、およびSLジブ作業は行わないでください。
6. 定置つり作業はパーキングブレーキを効かせ、同時にブレーキロックを掛けた状態で行ってください。
7. 走行つりはシフトセクターを1速にして「低速レンジスイッチ」を押して行ってください。  
なお、カウンタウエイト装着状態では、走行つり作業は行わないでください。
8. 走行つりは荷が振れないように地面近くに保持し、2km/h未満にて行ってください。  
特にコーナリング、急発進、急制動に注意してください。
9. 走行つり中にはクレーン作業は行わないでください。また旋回ブレーキを必ず掛けてください。
10. ブーム長さ、ブーム角度、作業半径、ジブ長さおよび角度が規定の値をこえる場合にはその規定の値と、次の規定の値の定格総荷重のうち小さい方の定格総荷重を目安として作業を行ってください。
11. 各々の作業状態における危険角度は表のとおりです。ブームを危険角度以下にしますと無負荷でも転倒しますので充分注意してください。
12. 高速巻下作業は、フックのみを降下するときに使用してください。また急激なレバー操作はさけてください。
13. 各ブーム長さに対する標準フック巻掛本数は表のとおりです。ただし標準巻掛本数以外の掛数で使用する場合は、ワイヤロープ1本当たり45.1kN (4.6tf) を限度としてください。
14. クレーン作業は風速10m/sまで可能ですが、比較的弱い風の場合でも受風面積の大きい荷重を取扱う場合は特別な注意を払ってください。
15. 定格総荷重をこえる作業を行った場合、および正しい使い方を行わなかった場合は転倒または破損します。この場合本機の保証はいたしません。



# ■作業範囲図

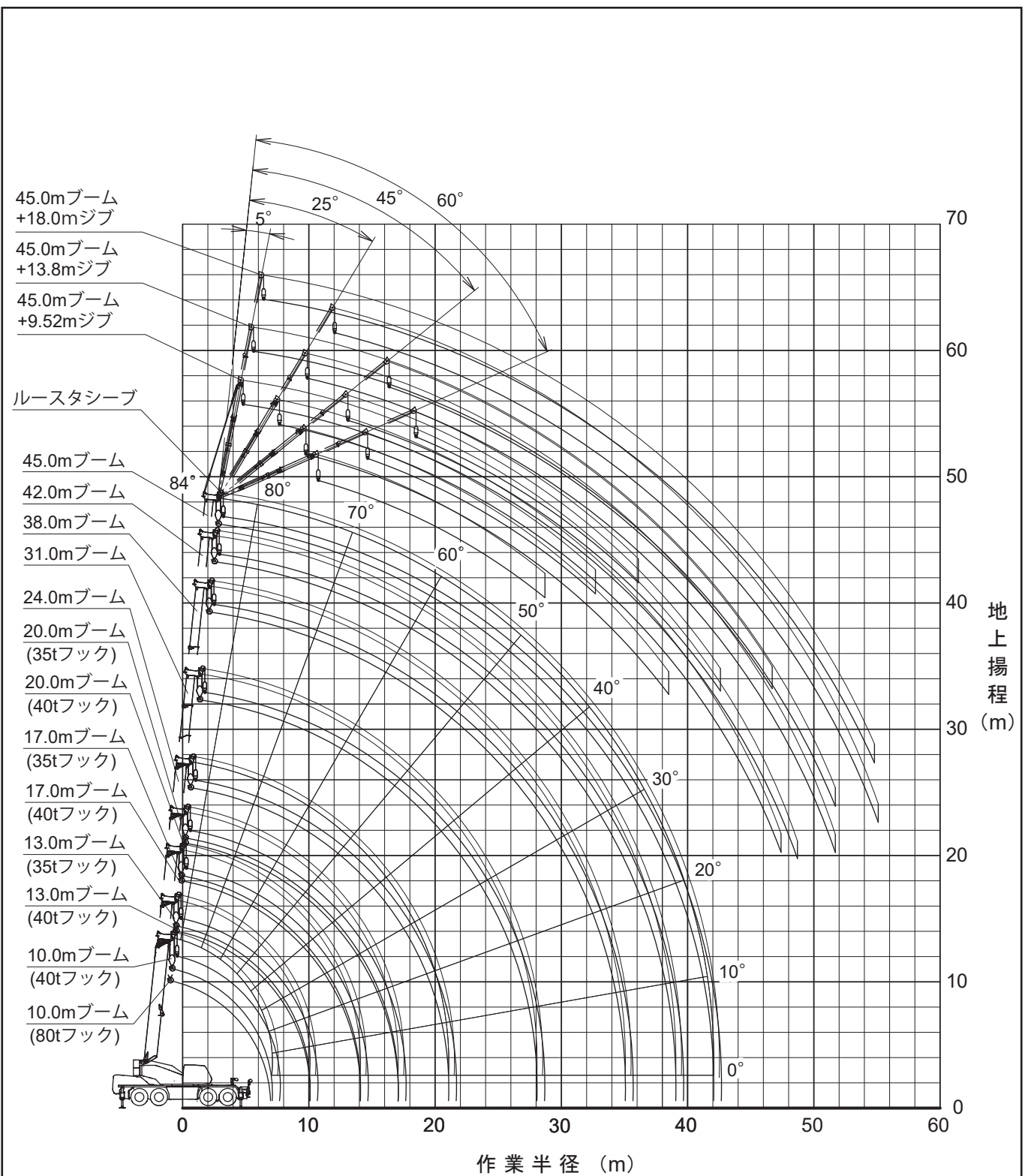

- (注意) 1. 本図はブーム・ジブのたわみを含んでいません。  
 2. 本図はカウンタウエイト付、アウトリガ張出(前方)のものです。







通常伸縮 カウンタウエイト付	ブーム	ジブ	アウトリガ 前方	作業範囲
-------------------	-----	----	-------------	------

ブーム [m]	10.0	13.0	17.0	20.0	24.0	31.0	38.0	42.0	45.0
2.2	80.00#	40.00*	40.00*	38.00*					
2.3	75.00*	40.00*	40.00*	38.00*	35.00				
2.5	71.00*	40.00*	40.00*	38.00*	35.00	14.00			
3.0	63.00*	40.00*	40.00*	38.00*	35.00	14.00			
3.5	57.50*	40.00*	40.00*	38.00*	35.00	14.00	13.00		
4.0	52.00*	40.00*	40.00*	37.00*	32.50	14.00	13.00	10.20	
4.5	48.00*	40.00*	40.00*	34.00	30.30	14.00	13.00	10.20	8.20
5.0	44.00*	40.00*	39.00*	32.00	28.30	14.00	13.00	10.20	8.20
5.5	40.00	40.00*	37.00*	30.00	26.50	14.00	13.00	10.20	8.20
6.0	37.00	37.00*	35.00	28.50	24.90	14.00	13.00	10.20	8.20
6.5	34.00	34.00	32.70	27.00	23.50	14.00	13.00	10.20	8.20
7.0		31.30	30.50	25.50	22.20	14.00	13.00	10.20	8.20
8.0		26.90	26.00	23.00	19.90	14.00	13.00	10.20	8.20
9.0		23.50	23.00	21.00	18.10	14.00	13.00	10.20	8.20
10.0			20.50	19.50	16.50	14.00	12.70	10.20	8.20
11.0			18.50	17.70	15.10	13.10	12.10	10.20	8.20
12.0			16.50	16.20	13.90	12.10	11.10	10.20	8.20
13.0			14.50	14.50	12.90	11.10	10.20	9.55	8.20
14.0				13.10	11.90	10.30	9.50	8.95	8.10
15.0				11.90	11.10	9.60	8.80	8.45	7.70
16.0				10.80	10.30	9.00	8.20	7.95	7.20
17.0					9.65	8.40	7.60	7.45	6.75
18.0					9.00	7.90	6.90	6.85	6.30
19.0					8.10	7.45	6.50	6.35	5.90
20.0					7.30	7.00	6.10	5.85	5.50
21.0						6.50	5.70	5.40	5.20
22.0						6.15	5.40	5.10	4.90
23.0						5.85	5.10	4.75	4.55
24.0						5.50	4.80	4.50	4.30
26.0						4.80	4.30	4.00	3.90
28.0						4.10	3.85	3.60	3.50
30.0							3.45	3.20	3.10
32.0							3.15	2.95	2.80
33.0							3.00	2.80	2.65
34.0							2.85	2.65	2.55
36.0								2.45	2.30
38.0								2.20	2.10
40.0									1.90
41.0									1.80
危険角度 標準フック	[°]	—	—	—	—	—	—	—	—
フック質量	[kg]	830*/470	470*/330			330			
巻掛本数	[本]	20*/10	10*/7			7	4		

(単位 : ton)





注 #: 前方左右各15°の旋回範囲のみ









		通常伸縮 カウンタウエイト付			ブーム	ジブ	アウトリガ 7.6m	作業範囲		
 [m]		10.0	13.0	17.0	20.0	24.0	31.0	38.0	42.0	45.0
 [m]	2.3	75.00*	40.00*	40.00*	38.00*	35.00				
	2.5	71.00*	40.00*	40.00*	38.00*	35.00	14.00			
	3.0	63.00*	40.00*	40.00*	38.00*	35.00	14.00			
	3.5	57.50*	40.00*	40.00*	38.00*	35.00	14.00	13.00		
	4.0	52.00*	40.00*	40.00*	37.00*	32.50	14.00	13.00	10.20	
	4.5	48.00*	40.00*	40.00*	34.00	30.30	14.00	13.00	10.20	8.20
	5.0	44.00*	40.00*	39.00*	32.00	28.30	14.00	13.00	10.20	8.20
	5.5	40.00	40.00*	37.00*	30.00	26.50	14.00	13.00	10.20	8.20
	6.0	37.00	37.00*	35.00	28.50	24.90	14.00	13.00	10.20	8.20
	6.5	34.00	34.00	32.70	27.00	23.50	14.00	13.00	10.20	8.20
	7.0		31.30	30.50	25.50	22.20	14.00	13.00	10.20	8.20
	8.0		26.90	26.00	23.00	19.90	14.00	13.00	10.20	8.20
	9.0		23.50	23.00	21.00	18.10	14.00	13.00	10.20	8.20
	10.0			18.90	18.75	16.50	14.00	12.70	10.20	8.20
	11.0			15.70	15.55	15.10	13.10	12.10	10.20	8.20
	12.0			13.25	13.15	13.10	12.10	11.10	10.20	8.20
	13.0			11.40	11.25	11.20	11.10	10.20	9.55	8.20
	14.0				9.70	9.65	10.30	9.50	8.95	8.10
	15.0				8.50	8.40	9.40	8.80	8.45	7.70
	16.0				7.45	7.35	8.30	8.20	7.95	7.20
	17.0					6.45	7.40	7.60	7.45	6.75
	18.0					5.65	6.60	6.90	6.85	6.30
	19.0					4.95	5.90	6.40	6.35	5.90
	20.0					4.35	5.25	5.80	5.85	5.50
21.0						4.70	5.20	5.40	5.20	
22.0						4.20	4.70	4.95	4.90	
23.0						3.75	4.25	4.45	4.55	
24.0						3.35	3.85	4.05	4.15	
26.0						2.70	3.15	3.35	3.45	
28.0						2.15	2.55	2.75	2.90	
30.0							2.10	2.25	2.40	
32.0							1.65	1.85	1.95	
33.0							1.45	1.65	1.75	
34.0							1.30	1.45	1.60	
36.0								1.15	1.25	
38.0								0.85	0.95	
40.0									0.70	
 危険 角度	[°]	—	—	—	—	—	—	—	—	—
 標準 フック	[ton]	80*/40	40*/35			35				
 フック 質量	[kg]	830*/470	470*/330			330				
 巻掛 本数	[本]	20*/10	10*/7			7	4			

(単位 : ton)

通常伸縮 カウンタウエイト付	ブーム 	ジブ	アウトリガ  7.2m	作業範囲 
-------------------	--	----	--	---







 [m]	10.0	13.0	17.0	20.0	24.0	31.0	38.0	42.0	45.0
2.3	55.00*	40.00*	40.00*	38.00*	35.00				
2.5	55.00*	40.00*	40.00*	38.00*	35.00	14.00			
3.0	55.00*	40.00*	40.00*	38.00*	35.00	14.00			
3.5	52.00*	40.00*	40.00*	38.00*	35.00	14.00	13.00		
4.0	48.00*	40.00*	40.00*	37.00*	32.50	14.00	13.00	10.20	
4.5	44.00*	40.00*	40.00*	34.00	30.30	14.00	13.00	10.20	8.20
5.0	40.00	40.00*	39.00*	32.00	28.30	14.00	13.00	10.20	8.20
5.5	36.00	36.00*	36.00*	30.00	26.50	14.00	13.00	10.20	8.20
6.0	33.10	33.10	33.10	28.50	24.90	14.00	13.00	10.20	8.20
6.5	30.70	30.70	30.70	27.00	23.50	14.00	13.00	10.20	8.20
7.0		28.60	28.60	25.50	22.20	14.00	13.00	10.20	8.20
8.0		25.00	25.00	23.00	19.90	14.00	13.00	10.20	8.20
9.0		21.30	21.05	20.90	18.10	14.00	13.00	10.20	8.20
10.0			17.15	17.00	16.50	14.00	12.70	10.20	8.20
11.0			14.25	14.10	14.10	13.10	12.10	10.20	8.20
12.0			12.05	11.95	11.90	12.10	11.10	10.20	8.20
13.0			10.35	10.20	10.15	11.10	10.20	9.55	8.20
14.0				8.80	8.75	9.75	9.50	8.95	8.10
15.0				7.65	7.60	8.55	8.80	8.45	7.70
16.0				6.75	6.65	7.55	8.20	7.95	7.20
17.0					5.80	6.70	7.20	7.45	6.75
18.0					5.05	6.00	6.45	6.85	6.30
19.0					4.40	5.35	5.80	6.00	5.90
20.0					3.85	4.75	5.25	5.45	5.50
21.0						4.20	4.75	4.95	5.20
22.0						3.75	4.25	4.50	4.60
23.0						3.35	3.85	4.05	4.20
24.0						2.95	3.45	3.65	3.75
26.0						2.35	2.80	3.00	3.10
28.0						1.80	2.25	2.45	2.55
30.0							1.80	2.00	2.10
32.0							1.35	1.55	1.70
33.0							1.20	1.40	1.50
34.0							1.00	1.20	1.30
36.0								0.90	1.00
38.0									0.70
 危険 角度	[°]	—	—	—	—	—	—	—	13
 標準 フック	[ton]	80*/40	40*/35			35			
 フック 質量	[kg]	830*/470	470*/330			330			
 巻掛 本数	[本]	20*/10	10*/7		7	4			

(単位 : ton)







		通常伸縮 カウンタウエイト付			ブーム	ジブ	アウトリガ 6.5m	作業範囲		
 [m]		10.0	13.0	17.0	20.0	24.0	31.0	38.0	42.0	45.0
 [m]	2.3	50.00*	40.00*	40.00*	38.00*	35.00				
	2.5	50.00*	40.00*	40.00*	38.00*	35.00	14.00			
	3.0	50.00*	40.00*	40.00*	38.00*	35.00	14.00			
	3.5	50.00*	40.00*	40.00*	38.00*	35.00	14.00	13.00		
	4.0	44.00*	40.00*	40.00*	37.00*	32.50	14.00	13.00	10.20	
	4.5	40.00	40.00*	40.00*	34.00	30.30	14.00	13.00	10.20	8.20
	5.0	36.00	36.00*	36.00*	32.00	28.30	14.00	13.00	10.20	8.20
	5.5	33.20	33.20	33.20	30.00	26.50	14.00	13.00	10.20	8.20
	6.0	30.70	30.70	30.70	28.50	24.90	14.00	13.00	10.20	8.20
	6.5	28.50	28.50	28.50	27.00	23.50	14.00	13.00	10.20	8.20
	7.0		26.50	26.50	25.50	22.20	14.00	13.00	10.20	8.20
	8.0		22.40	22.15	22.00	19.90	14.00	13.00	10.20	8.20
	9.0		17.80	17.60	17.45	17.45	14.00	13.00	10.20	8.20
	10.0			14.35	14.25	14.20	14.00	12.70	10.20	8.20
	11.0			11.95	11.85	11.80	12.90	12.10	10.20	8.20
	12.0			10.15	10.00	9.95	11.00	11.10	10.20	8.20
	13.0			8.65	8.55	8.50	9.45	10.20	9.55	8.20
	14.0				7.35	7.30	8.25	8.75	8.95	8.10
	15.0				6.35	6.30	7.20	7.70	7.90	7.70
	16.0				5.55	5.45	6.35	6.85	7.05	7.20
	17.0					4.75	5.60	6.10	6.30	6.75
	18.0					4.05	5.00	5.45	5.65	5.75
	19.0					3.50	4.40	4.90	5.05	5.20
	20.0					3.00	3.90	4.40	4.55	4.70
	21.0						3.40	3.95	4.15	4.25
	22.0						3.00	3.50	3.70	3.85
	23.0						2.65	3.10	3.30	3.45
	24.0						2.30	2.80	3.00	3.10
26.0						1.70	2.20	2.40	2.50	
28.0						1.20	1.70	1.90	2.00	
30.0							1.25	1.45	1.60	
32.0							0.85	1.05	1.20	
33.0							0.70	0.90	1.00	
34.0								0.75	0.85	
 危険 角度	[°]	—	—	—	—	—	—	—	21	28
 標準 フック	[ton]	80*/40	40*/35			35				
 フック 質量	[kg]	830*/470	470*/330			330				
 巻掛 本数	[本]	20*/10	10*/7			7	4			

(単位 : ton)



通常伸縮 カウンタウエイト付	ブーム 	ジブ	アウトリガ  5.4m	作業範囲 
-------------------	--	----	--	---





 [m]	10.0	13.0	17.0	20.0	24.0	31.0	38.0	42.0	45.0	
 [m]	2.3	50.00*	40.00*	40.00*	38.00*	35.00				
	2.5	50.00*	40.00*	40.00*	38.00*	35.00	14.00			
	3.0	50.00*	40.00*	40.00*	38.00*	35.00	14.00			
	3.5	46.00*	40.00*	40.00*	38.00*	35.00	14.00	13.00		
	4.0	42.00*	40.00*	40.00*	37.00*	32.50	14.00	13.00	10.20	
	4.5	37.20	37.20*	37.20*	34.00	30.30	14.00	13.00	10.20	8.20
	5.0	33.90	33.90	33.90	32.00	28.30	14.00	13.00	10.20	8.20
	5.5	30.80	30.80	30.60	30.00	26.50	14.00	13.00	10.20	8.20
	6.0	28.80	28.80	28.30	28.00	24.90	14.00	13.00	10.20	8.20
	6.5	24.45	24.30	24.05	23.90	23.15	14.00	13.00	10.20	8.20
	7.0		21.05	20.80	20.65	20.60	14.00	13.00	10.20	8.20
	8.0		16.35	16.10	16.00	15.95	14.00	13.00	10.20	8.20
	9.0		13.10	12.90	12.75	12.75	13.85	13.00	10.20	8.20
	10.0			10.55	10.45	10.40	11.45	11.85	10.20	8.20
	11.0			8.80	8.65	8.65	9.65	10.15	10.20	8.20
	12.0			7.40	7.30	7.25	8.20	8.70	8.90	8.20
	13.0			6.30	6.15	6.15	7.05	7.55	7.75	7.85
	14.0				5.25	5.20	6.10	6.55	6.75	6.90
	15.0				4.50	4.45	5.30	5.75	5.95	6.05
	16.0				3.85	3.80	4.60	5.05	5.25	5.35
	17.0					3.15	4.05	4.50	4.65	4.75
	18.0					2.60	3.50	3.95	4.15	4.25
	19.0					2.10	3.00	3.50	3.70	3.80
	20.0					1.70	2.60	3.10	3.30	3.40
	21.0						2.20	2.70	2.95	3.05
	22.0						1.85	2.35	2.55	2.70
	23.0						1.55	2.05	2.25	2.35
	24.0						1.25	1.75	1.95	2.10
26.0						0.70	1.25	1.45	1.60	
28.0							0.80	1.00	1.10	
30.0									0.75	
 危険 角度	[°]	—	—	—	—	—	10	31	37	40
 標準 フック	[ton]	80*/40	40*/35			35				
 フック 質量	[kg]	830*/470	470*/330			330				
 巻掛 本数	[本]	20*/10	10*/7			7	4			

(単位 : ton)

		通常伸縮 カウンタウエイト付			ブーム	ジブ	アウトリガ 4.3m	作業範囲		
 [m]		10.0	13.0	17.0	20.0	24.0	31.0	38.0	42.0	45.0
 [m]	2.3	40.00*	40.00*	40.00*	38.00*	35.00				
	2.5	40.00*	40.00*	40.00*	38.00*	35.00	14.00			
	3.0	40.00*	40.00*	40.00*	38.00*	35.00	14.00			
	3.5	40.00*	40.00*	40.00*	38.00*	35.00	14.00	13.00		
	4.0	37.10*	37.00*	36.90*	36.80*	32.50	14.00	13.00	10.20	
	4.5	33.50	33.40	33.05	30.85	28.60	14.00	13.00	10.20	8.20
	5.0	27.70	27.60	27.35	26.20	24.45	14.00	13.00	10.20	8.20
	5.5	23.05	22.95	22.70	22.55	21.20	14.00	13.00	10.20	8.20
	6.0	19.60	19.50	19.25	19.10	18.60	14.00	13.00	10.20	8.20
	6.5	16.95	16.80	16.60	16.45	16.45	14.00	13.00	10.20	8.20
	7.0		14.65	14.45	14.35	14.35	14.00	13.00	10.20	8.20
	8.0		11.50	11.30	11.20	11.15	12.15	12.00	10.20	8.20
	9.0		9.25	9.05	8.95	8.90	9.90	10.15	10.05	8.20
	10.0			7.35	7.25	7.25	8.20	8.65	8.60	8.20
	11.0			6.05	5.95	5.95	6.85	7.35	7.45	7.45
	12.0			5.05	4.95	4.90	5.80	6.25	6.45	6.50
	13.0			4.20	4.10	4.05	4.90	5.35	5.55	5.65
	14.0				3.40	3.35	4.20	4.65	4.80	4.95
	15.0				2.80	2.70	3.55	4.00	4.20	4.30
	16.0				2.20	2.15	3.05	3.50	3.65	3.75
	17.0					1.60	2.60	3.00	3.20	3.30
	18.0					1.15	2.15	2.60	2.80	2.90
	19.0					0.75	1.70	2.25	2.45	2.55
	20.0						1.35	1.90	2.05	2.20
21.0						1.00	1.55	1.75	1.90	
22.0						0.70	1.25	1.45	1.60	
23.0							0.95	1.20	1.30	
24.0							0.70	0.95	1.05	
 危険 角度	[°]	—	—	—	—	19	35	46	50	53
 標準 フック	[ton]	40*/35				35				
 フック 質量	[kg]	470*/330				330				
 巻掛 本数	[本]	10*/7				7	4			





(単位 : ton)

通常伸縮 カウンタウエイト無	ブーム 	ジブ	アウトリガ  前方	作業範囲 
-------------------	--	----	--	---

 [m]	10.0	13.0	17.0	20.0	24.0	31.0	38.0	42.0	45.0
2.3	75.00*	40.00*	40.00*	38.00*	35.00				
2.5	71.00*	40.00*	40.00*	38.00*	35.00	14.00			
3.0	63.00*	40.00*	40.00*	38.00*	35.00	14.00			
3.5	57.50*	40.00*	40.00*	38.00*	35.00	14.00	13.00		
4.0	52.00*	40.00*	40.00*	37.00*	32.50	14.00	13.00	10.20	
4.5	48.00*	40.00*	40.00*	34.00	30.30	14.00	13.00	10.20	8.20
5.0	43.00*	40.00*	39.00*	32.00	28.30	14.00	13.00	10.20	8.20
5.5	39.00	38.60*	37.00*	30.00	26.50	14.00	13.00	10.20	8.20
6.0	35.50	35.15*	35.00	28.50	24.90	14.00	13.00	10.20	8.20
6.5	32.50	32.20	32.10	27.00	23.50	14.00	13.00	10.20	8.20
7.0		29.70	29.60	25.50	22.20	14.00	13.00	10.20	8.20
8.0		25.50	25.40	23.00	19.90	14.00	13.00	10.20	8.20
9.0		22.15	22.15	21.00	18.10	14.00	13.00	10.20	8.20
10.0			19.50	19.00	16.50	14.00	12.70	10.20	8.20
11.0			17.35	17.30	15.10	13.10	12.10	10.20	8.20
12.0			14.85	14.45	13.90	12.10	11.10	10.20	8.20
13.0			12.60	12.50	12.45	11.10	10.20	9.55	8.20
14.0				11.10	11.00	10.30	9.50	8.95	8.10
15.0				9.90	9.80	9.60	8.80	8.45	7.70
16.0				8.60	8.50	9.00	8.20	7.95	7.20
17.0					7.50	8.10	7.60	7.45	6.75
18.0					6.50	7.15	6.90	6.85	6.30
19.0					5.70	6.50	6.50	6.35	5.90
20.0					4.95	5.90	6.10	5.85	5.50
21.0						5.30	5.70	5.40	5.20
22.0						4.80	5.20	5.10	4.90
23.0						4.25	4.75	4.75	4.55
24.0						3.85	4.40	4.50	4.30
26.0						2.95	3.60	3.70	3.90
28.0						2.20	2.90	3.10	3.25
30.0							2.30	2.60	2.65
32.0							1.80	2.10	2.15
33.0							1.60	1.85	1.95
34.0							1.40	1.65	1.75
36.0								1.25	1.35
38.0								0.95	1.05
40.0									0.80
41.0									0.65
 危険 角度	[°]	—	—	—	—	—	—	—	—
 標準 フック	[ton]	80*/40	40*/35			35			
 フック 質量	[kg]	830*/470	470*/330			330			
 巻掛 本数	[本]	20*/10	10*/7			7	4		



(単位 : ton)





通常伸縮 カウンタウエイト無	ブーム 	ジブ	アウトリガ  7.6m	作業範囲 
-------------------	--	----	--	---

 [m]	10.0	13.0	17.0	20.0	24.0	31.0	38.0	42.0	45.0	
2.3	75.00*	40.00*	40.00*	38.00*	35.00					
2.5	71.00*	40.00*	40.00*	38.00*	35.00	14.00				
3.0	63.00*	40.00*	40.00*	38.00*	35.00	14.00				
3.5	57.50*	40.00*	40.00*	38.00*	35.00	14.00	13.00			
4.0	52.00*	40.00*	40.00*	37.00*	32.50	14.00	13.00	10.20		
4.5	48.00*	40.00*	40.00*	34.00	30.30	14.00	13.00	10.20	8.20	
5.0	43.00*	40.00*	39.00*	32.00	28.30	14.00	13.00	10.20	8.20	
5.5	39.00	38.60*	37.00*	30.00	26.50	14.00	13.00	10.20	8.20	
6.0	35.50	35.15*	35.00	28.50	24.90	14.00	13.00	10.20	8.20	
6.5	32.50	32.20	32.10	27.00	23.50	14.00	13.00	10.20	8.20	
7.0		29.70	29.60	25.50	22.20	14.00	13.00	10.20	8.20	
8.0		23.70	23.60	23.00	19.90	14.00	13.00	10.20	8.20	
9.0		18.30	18.25	18.20	18.10	14.00	13.00	10.20	8.20	
10.0			14.65	14.55	14.50	14.00	12.70	10.20	8.20	
11.0			12.05	11.95	11.90	13.05	12.10	10.20	8.20	
12.0			10.05	9.95	9.90	11.00	11.10	10.20	8.20	
13.0			8.50	8.40	8.35	9.40	10.20	9.55	8.20	
14.0				7.15	7.00	8.10	8.60	8.95	8.10	
15.0				6.15	5.95	7.00	7.55	7.80	7.70	
16.0				5.20	5.05	6.05	6.65	6.85	7.20	
17.0					4.25	5.30	5.85	6.05	6.20	
18.0					3.60	4.60	5.15	5.35	5.50	
19.0					3.05	4.00	4.55	4.75	4.90	
20.0					2.60	3.50	4.00	4.20	4.35	
21.0						3.05	3.55	3.75	3.90	
22.0						2.65	3.15	3.35	3.45	
23.0						2.30	2.75	3.00	3.10	
24.0						1.95	2.45	2.65	2.75	
26.0						1.35	1.85	2.10	2.20	
28.0						0.85	1.35	1.60	1.70	
30.0							0.95	1.15	1.30	
32.0							0.55	0.80	0.95	
33.0								0.65	0.80	
34.0									0.65	
 危険 角度	[°]	—	—	—	—	—	—	19	28	33
 標準 フック	[ton]	80*/40	40*/35			35				
 フック 質量	[kg]	830*/470	470*/330			330				
 巻掛 本数	[本]	20*/10	10*/7			7	4			

(単位 : ton)









通常伸縮 カウンタウエイト無	ブーム 	ジブ	アウトリガ  7.2m	作業範囲 
-------------------	--	----	--	---

 [m]	10.0	13.0	17.0	20.0	24.0	31.0	38.0	42.0	45.0	
2.3	55.00*	40.00*	40.00*	38.00*	35.00					
2.5	55.00*	40.00*	40.00*	38.00*	35.00	14.00				
3.0	55.00*	40.00*	40.00*	38.00*	35.00	14.00				
3.5	50.00*	40.00*	40.00*	38.00*	35.00	14.00	13.00			
4.0	45.40*	40.00*	40.00*	37.00*	32.50	14.00	13.00	10.20		
4.5	41.40*	40.00*	40.00*	34.00	30.30	14.00	13.00	10.20	8.20	
5.0	37.90	37.80*	37.80*	32.00	28.30	14.00	13.00	10.20	8.20	
5.5	34.90	34.80	34.80	30.00	26.50	14.00	13.00	10.20	8.20	
6.0	32.30	32.20	32.10	28.50	24.90	14.00	13.00	10.20	8.20	
6.5	30.00	29.90	29.80	27.00	23.50	14.00	13.00	10.20	8.20	
7.0		28.50	27.70	25.00	22.20	14.00	13.00	10.20	8.20	
8.0		21.15	20.85	20.70	19.90	14.00	13.00	10.20	8.20	
9.0		16.50	16.25	16.10	16.10	14.00	13.00	10.20	8.20	
10.0			13.05	12.90	12.90	14.00	12.70	10.20	8.20	
11.0			10.70	10.60	10.55	11.70	12.10	10.20	8.20	
12.0			8.95	8.80	8.75	9.85	10.35	10.20	8.20	
13.0			7.55	7.40	7.35	8.40	8.95	9.05	8.20	
14.0				6.30	6.25	7.20	7.75	7.95	8.10	
15.0				5.35	5.30	6.25	6.75	7.00	7.10	
16.0				4.55	4.45	5.45	5.95	6.15	6.25	
17.0					3.70	4.75	5.25	5.45	5.55	
18.0					3.10	4.10	4.65	4.85	4.95	
19.0					2.50	3.55	4.10	4.30	4.40	
20.0					2.00	3.05	3.55	3.80	3.95	
21.0						2.60	3.15	3.35	3.45	
22.0						2.20	2.75	2.95	3.10	
23.0						1.85	2.40	2.60	2.75	
24.0						1.50	2.05	2.30	2.40	
26.0						0.95	1.55	1.75	1.85	
28.0							1.05	1.30	1.40	
30.0							0.65	0.85	1.00	
32.0									0.65	
 危険 角度 標準 フック	[°]	—	—	—	—	—	—	26	33	37
 フック 質量	[kg]	830*/470	470*/330			330				
 巻掛 本数	[本]	20*/10	10*/7			7	4			







(単位 : ton)

通常伸縮 カウンタウエイト無	ブーム 	ジブ	アウトリガ  6.5m	作業範囲 
-------------------	--	----	--	---







 [m]	10.0	13.0	17.0	20.0	24.0	31.0	38.0	42.0	45.0	
 [m]	2.3	50.00*	40.00*	40.00*	38.00*	35.00				
	2.5	50.00*	40.00*	40.00*	38.00*	35.00	14.00			
	3.0	50.00*	40.00*	40.00*	38.00*	35.00	14.00			
	3.5	48.00*	40.00*	40.00*	38.00*	35.00	14.00	13.00		
	4.0	43.50*	40.00*	40.00*	37.00*	32.50	14.00	13.00	10.20	
	4.5	39.60	39.50*	39.40*	34.00	30.30	14.00	13.00	10.20	8.20
	5.0	36.20	36.10*	36.00*	32.00	28.30	14.00	13.00	10.20	8.20
	5.5	33.30	33.15	33.00	30.00	26.50	14.00	13.00	10.20	8.20
	6.0	30.70	30.60	30.50	28.00	24.90	14.00	13.00	10.20	8.20
	6.5	26.90	26.75	26.60	25.90	23.50	14.00	13.00	10.20	8.20
	7.0		22.85	22.55	22.40	21.30	14.00	13.00	10.20	8.20
	8.0		17.20	17.00	16.80	16.85	14.00	13.00	10.20	8.20
	9.0		13.50	13.30	13.15	13.15	14.00	13.00	10.20	8.20
	10.0			10.70	10.55	10.55	11.70	11.70	10.20	8.20
	11.0			8.80	8.65	8.65	9.70	10.05	10.00	8.20
	12.0			7.30	7.15	7.15	8.15	8.70	8.70	8.20
	13.0			6.10	6.00	5.95	6.95	7.45	7.60	7.60
	14.0				5.00	5.00	5.95	6.45	6.65	6.70
	15.0				4.20	4.15	5.10	5.60	5.80	5.95
	16.0				3.45	3.45	4.40	4.90	5.10	5.20
	17.0					2.75	3.80	4.30	4.50	4.60
	18.0					2.15	3.25	3.75	3.95	4.10
	19.0					1.65	2.75	3.25	3.45	3.60
	20.0					1.20	2.25	2.80	3.00	3.15
	21.0						1.95	2.45	2.65	2.75
	22.0						1.50	2.10	2.30	2.40
	23.0						1.15	1.75	2.00	2.15
	24.0						0.85	1.45	1.70	1.85
26.0							0.90	1.10	1.35	
28.0								0.70	0.85	
 危険 角度	[°]	—	—	—	—	—	21	35	41	45
 標準 フック	[ton]	80*/40	40*/35			35				
 フック 質量	[kg]	830*/470	470*/330			330				
 巻掛 本数	[本]	20*/10	10*/7			7	4			

(単位 : ton)







通常伸縮 カウンタウエイト無	ブーム 	ジブ	アウトリガ  5.4m	作業範囲 
-------------------	--	----	--	---

 [m]	10.0	13.0	17.0	20.0	24.0	31.0	38.0	42.0	45.0	
 [m]	2.3	50.00*	40.00*	40.00*	38.00*	35.00				
	2.5	50.00*	40.00*	40.00*	38.00*	35.00	14.00			
	3.0	49.80*	40.00*	40.00*	38.00*	35.00	14.00			
	3.5	44.50*	40.00*	40.00*	38.00*	35.00	14.00	13.00		
	4.0	40.00	40.00*	40.00*	37.00*	32.50	14.00	13.00	10.20	
	4.5	36.20	36.10*	36.00*	34.00	30.30	14.00	13.00	10.20	8.20
	5.0	33.00	32.95	31.20	29.05	26.80	14.00	13.00	10.20	8.20
	5.5	26.55	26.45	26.15	24.55	22.85	14.00	13.00	10.20	8.20
	6.0	22.00	21.90	21.60	21.10	19.70	14.00	13.00	10.20	8.20
	6.5	18.65	18.50	18.25	18.10	17.20	14.00	13.00	10.20	8.20
	7.0		15.90	15.65	15.50	15.15	14.00	13.00	10.20	8.20
	8.0		12.15	11.95	11.80	11.80	12.40	12.20	10.20	8.20
	9.0		9.60	9.40	9.25	9.25	10.20	10.20	10.10	8.20
	10.0			7.50	7.40	7.40	8.40	8.60	8.60	8.20
	11.0			6.10	6.00	6.00	6.95	7.35	7.35	7.35
	12.0			5.00	4.90	4.85	5.80	6.30	6.35	6.35
	13.0			4.10	4.00	3.95	4.90	5.35	5.50	5.50
	14.0				3.30	3.20	4.10	4.50	4.75	4.80
	15.0				2.60	2.50	3.45	3.95	4.15	4.20
	16.0				2.00	1.85	2.90	3.40	3.60	3.65
	17.0					1.30	2.40	2.90	3.10	3.20
	18.0					0.80	1.90	2.45	2.65	2.80
	19.0						1.45	2.05	2.25	2.40
20.0						1.05	1.65	1.90	2.05	
21.0						0.75	1.30	1.55	1.70	
22.0							1.00	1.25	1.40	
23.0								0.70	0.85	
 危険 角度	[°]	—	—	—	—	24	37	48	53	55
 標準 フック	[ton]	80*/40	40*/35			35				
 フック 質量	[kg]	830*/470	470*/330			330				
 巻掛 本数	[本]	20*/10	10*/7			7	4			









(単位 : ton)

		通常伸縮 カウンタウエイト無			ブーム	ジブ	アウトリガ 4.3m	作業範囲		
 [m]		10.0	13.0	17.0	20.0	24.0	31.0	38.0	42.0	45.0
 [m]	2.3	40.00*	40.00*	40.00*	38.00*	35.00				
	2.5	40.00*	40.00*	40.00*	38.00*	35.00	14.00			
	3.0	40.00*	40.00*	40.00*	38.00*	35.00	14.00			
	3.5	40.00*	40.00*	37.90*	34.60	31.20	14.00	13.00		
	4.0	32.00	31.00	30.05	27.70	25.35	14.00	13.00	10.20	
	4.5	25.70	25.00	24.60	22.85	20.15	14.00	13.00	10.20	8.20
	5.0	20.60	20.45	20.30	19.20	17.85	14.00	13.00	10.20	8.20
	5.5	17.00	16.85	16.70	16.40	15.30	14.00	13.00	10.20	8.20
	6.0	14.40	14.20	14.00	14.00	13.25	13.35	12.95	10.20	8.20
	6.5	12.30	12.10	11.90	11.90	11.55	11.85	11.60	10.20	8.20
	7.0		10.30	10.30	10.25	10.20	10.55	10.40	10.20	8.20
	8.0		7.90	7.80	7.80	7.70	8.50	8.50	8.45	8.20
	9.0		6.20	6.10	6.05	6.00	6.90	7.05	7.05	7.00
	10.0			4.80	4.70	4.70	5.60	5.90	5.90	5.90
	11.0			3.80	3.70	3.65	4.55	4.90	5.00	5.00
	12.0			3.00	2.90	2.85	3.70	4.15	4.20	4.25
	13.0			2.30	2.15	2.10	3.00	3.45	3.55	3.60
14.0				1.50	1.40	2.45	2.90	3.00	3.05	
15.0				0.95	0.90	1.90	2.40	2.50	2.60	
16.0						1.40	1.95	2.10	2.15	
17.0							1.55	1.70	1.80	
 危険 角度 標準 フック	[°]	—	—	—	21	43	53	59	62	64
 標準 フック	[ton]	40*/35				35				
 フック 質量	[kg]	470*/330				330				
 巻掛 本数	[本]	10*/7				7	4			





(単位: ton)

		通常伸縮 カウンタウエイト無			ブーム	ジブ	アウトリガ 2.55m	作業範囲		
 [m]		10.0	13.0	17.0	20.0	24.0				
 [m]	2.3	20.00	17.50	15.00	13.50	12.00				
	2.5	20.00	17.50	15.00	13.50	12.00				
	3.0	20.00	17.50	15.00	13.50	12.00				
	3.5	15.20	15.10	15.00	13.50	12.00				
	4.0	11.90	11.75	11.60	11.50	11.10				
	4.5	9.50	9.40	9.30	9.10	9.20				
	5.0	7.80	7.70	7.60	7.40	7.50				
	5.5	6.50	6.40	6.30	6.10	6.20				
	6.0	5.50	5.35	5.20	5.10	5.10				
	6.5	4.60	4.50	4.40	4.30	4.30				
	7.0		3.80	3.70	3.60	3.60				
8.0		2.70	2.60	2.50	2.50					
9.0		1.90	1.80	1.70						
10.0			1.20							
 危険 角度	[°]	—	—	41	55	64				
 標準 フック	[ton]					35				
 フック 質量	[kg]					330				
 巻掛 本数	[本]					4				

(単位: ton)

		特殊伸縮 カウンタウエイト付	ブーム 	ジブ	アウトリガ  前方	作業範囲 
 [m]		17.0		24.0		31.0
 [m]	2.5	14.00		13.00		9.00
	3.0	14.00		13.00		9.00
	3.5	14.00		13.00		9.00
	4.0	14.00		13.00		9.00
	4.5	14.00		13.00		9.00
	5.0	14.00		13.00		9.00
	5.5	14.00		13.00		9.00
	6.0	14.00		13.00		9.00
	6.5	14.00		12.70		9.00
	7.0	14.00		12.10		9.00
	8.0	14.00		11.00		9.00
	9.0	14.00		10.05		8.35
	10.0	13.00		9.25		7.65
	11.0	12.20		8.55		7.00
	12.0	11.50		7.95		6.40
	13.0	10.90		7.35		5.90
	14.0	10.40		6.85		5.45
	15.0			6.45		5.05
	16.0			6.00		4.70
	17.0			5.65		4.40
18.0			5.30		4.10	
19.0			4.95		3.85	
20.0			4.65		3.60	
21.0			4.45		3.40	
22.0					3.20	
23.0					3.00	
24.0					2.85	
26.0					2.55	
27.0					2.45	
 危険 角度	[°]	—		—		—
 標準 フック	[ton]			35		
 フック 質量	[kg]			330		
 巻掛 本数	[本]			4		

(単位 : ton)









		特殊伸縮 カウンタウエイト付	ブーム 	ジブ	アウトリガ  7.6m	作業範囲 
 [m]		17.0	24.0	31.0		
 [m]	2.5	14.00	13.00	9.00		
	3.0	14.00	13.00	9.00		
	3.5	14.00	13.00	9.00		
	4.0	14.00	13.00	9.00		
	4.5	14.00	13.00	9.00		
	5.0	14.00	13.00	9.00		
	5.5	14.00	13.00	9.00		
	6.0	14.00	13.00	9.00		
	6.5	14.00	12.70	9.00		
	7.0	14.00	12.10	9.00		
	8.0	14.00	11.00	9.00		
	9.0	14.00	10.05	8.35		
	10.0	13.00	9.25	7.65		
	11.0	12.20	8.55	7.00		
	12.0	11.50	7.95	6.40		
	13.0	10.90	7.35	5.90		
	14.0	10.40	6.85	5.45		
	15.0		6.45	5.05		
	16.0		6.00	4.70		
	17.0		5.65	4.40		
18.0		5.30	4.10			
19.0		4.95	3.85			
20.0		4.65	3.60			
21.0		4.45	3.40			
22.0			3.20			
23.0			3.00			
24.0			2.85			
26.0			2.55			
27.0			2.45			
 危険 角度	[°]	—	—	—		
 標準 フック	[ton]		35			
 フック 質量	[kg]		330			
 巻掛 本数	[本]		4			

(単位 : ton)





		特殊伸縮 カウンタウエイト付	ブーム 	ジブ	アウトリガ  7.2m	作業範囲 
 [m]		17.0		24.0		31.0
 [m]	2.5	14.00		13.00		9.00
	3.0	14.00		13.00		9.00
	3.5	14.00		13.00		9.00
	4.0	14.00		13.00		9.00
	4.5	14.00		13.00		9.00
	5.0	14.00		13.00		9.00
	5.5	14.00		13.00		9.00
	6.0	14.00		13.00		9.00
	6.5	14.00		12.70		9.00
	7.0	14.00		12.10		9.00
	8.0	14.00		11.00		9.00
	9.0	14.00		10.05		8.35
	10.0	13.00		9.25		7.65
	11.0	12.20		8.55		7.00
	12.0	11.50		7.95		6.40
	13.0	10.90		7.35		5.90
	14.0	10.40		6.85		5.45
	15.0			6.45		5.05
	16.0			6.00		4.70
	17.0			5.65		4.40
18.0			5.30		4.10	
19.0			4.95		3.85	
20.0			4.65		3.60	
21.0			4.45		3.40	
22.0					3.20	
23.0					3.00	
24.0					2.85	
26.0					2.55	
27.0					2.45	
 危険 角度	[°]	—		—		—
 標準 フック	[ton]			35		
 フック 質量	[kg]			330		
 巻掛 本数	[本]			4		

(単位 : ton)









		特殊伸縮 カウンタウエイト付	ブーム 	ジブ	アウトリガ  6.5m	作業範囲 
 [m]		17.0	24.0	31.0		
 [m]	2.5	14.00	13.00	9.00		
	3.0	14.00	13.00	9.00		
	3.5	14.00	13.00	9.00		
	4.0	14.00	13.00	9.00		
	4.5	14.00	13.00	9.00		
	5.0	14.00	13.00	9.00		
	5.5	14.00	13.00	9.00		
	6.0	14.00	13.00	9.00		
	6.5	14.00	12.70	9.00		
	7.0	14.00	12.10	9.00		
	8.0	14.00	11.00	9.00		
	9.0	14.00	10.05	8.35		
	10.0	13.00	9.25	7.65		
	11.0	12.20	8.55	7.00		
	12.0	11.50	7.95	6.40		
	13.0	10.60	7.35	5.90		
	14.0	9.35	6.85	5.45		
	15.0		6.45	5.05		
	16.0		6.00	4.70		
	17.0		5.65	4.40		
18.0		5.30	4.10			
19.0		4.95	3.85			
20.0		4.65	3.60			
21.0		4.45	3.40			
22.0			3.20			
23.0			3.00			
24.0			2.85			
26.0			2.55			
27.0			2.45			
 危険 角度	[°]	—	—	—		
 標準 フック	[ton]		35			
 フック 質量	[kg]		330			
 巻掛 本数	[本]		4			





(単位 : ton)















		特殊伸縮 カウンタウエイト付	ブーム 	ジブ	アウトリガ  5.4m	作業範囲 
 [m]		17.0	24.0	31.0		
 [m]	2.5	14.00	13.00	9.00		
	3.0	14.00	13.00	9.00		
	3.5	14.00	13.00	9.00		
	4.0	14.00	13.00	9.00		
	4.5	14.00	13.00	9.00		
	5.0	14.00	13.00	9.00		
	5.5	14.00	13.00	9.00		
	6.0	14.00	13.00	9.00		
	6.5	14.00	12.70	9.00		
	7.0	14.00	12.10	9.00		
	8.0	14.00	11.00	9.00		
	9.0	14.00	10.05	8.35		
	10.0	12.65	9.25	7.65		
	11.0	10.75	8.55	7.00		
	12.0	9.30	7.95	6.40		
	13.0	8.10	7.35	5.90		
	14.0	7.15	6.85	5.45		
	15.0		6.45	5.05		
	16.0		6.00	4.70		
	17.0		5.65	4.40		
18.0		5.00	4.10			
19.0		4.55	3.85			
20.0		4.15	3.60			
21.0		3.80	3.40			
22.0			3.20			
23.0			3.00			
24.0			2.85			
26.0			2.55			
27.0			2.45			
 危険 角度	[°]	—	—	—		
 標準 フック	[ton]		35			
 フック 質量	[kg]		330			
 巻掛 本数	[本]		4			



(単位 : ton)













		特殊伸縮 カウンタウエイト付	ブーム 	ジブ	アウトリガ  4.3m	作業範囲 
 [m]		17.0		24.0		31.0
 [m]	2.5	14.00		13.00		9.00
	3.0	14.00		13.00		9.00
	3.5	14.00		13.00		9.00
	4.0	14.00		13.00		9.00
	4.5	14.00		13.00		9.00
	5.0	14.00		13.00		9.00
	5.5	14.00		13.00		9.00
	6.0	14.00		13.00		9.00
	6.5	14.00		12.70		9.00
	7.0	14.00		12.10		9.00
	8.0	13.40		11.00		9.00
	9.0	11.05		10.05		8.35
	10.0	9.25		9.25		7.65
	11.0	7.90		8.55		7.00
	12.0	6.80		7.30		6.40
	13.0	5.90		6.40		5.90
	14.0	5.20		5.65		5.45
	15.0			5.00		5.05
	16.0			4.45		4.70
	17.0			4.00		4.40
18.0			3.60		4.10	
19.0			3.25		3.45	
20.0			2.95		3.10	
21.0			2.65		2.85	
22.0					2.60	
23.0					2.35	
24.0					2.15	
26.0					1.80	
27.0					1.60	
 危険 角度	[°]	—		—		—
 標準 フック	[ton]			35		
 フック 質量	[kg]			330		
 巻掛 本数	[本]			4		





(単位 : ton)













通常伸縮 カウンタウエイト付	ブーム 	ジブ  13.8m	アウトリガ  前方	作業範囲 
-------------------	--	---	--	---

 [m]	24.0								
	5		25		45		60		
 [°]									
	[m]	[ton]	[m]	[ton]	[m]	[ton]	[m]	[ton]	
84	3.7	2.80	8.2	2.65	11.3	1.55	12.8	1.00	
81	5.8	2.80	10.3	2.50	13.0	1.50	14.3	1.00	
78	7.8	2.75	12.1	2.35	14.7	1.45	15.8	1.00	
75	9.8	2.75	13.9	2.20	16.3	1.45	17.1	1.00	
72	11.8	2.70	15.5	2.05	17.8	1.40	18.5	1.00	
69	13.7	2.65	17.1	1.95	19.2	1.35	19.8	1.00	
66	15.5	2.50	18.6	1.85	20.6	1.35	21.0	1.00	
63	17.2	2.25	20.1	1.75	21.9	1.30			
60	18.9	2.10	21.6	1.65	23.2	1.30			
57	20.5	1.95	23.0	1.60	24.3	1.30			
54	22.1	1.80	24.4	1.55	25.4	1.25			
51	23.5	1.75	25.7	1.50	26.4	1.25			
49	24.5	1.65	26.5	1.45	27.1	1.25			
48	24.9	1.65	26.9	1.45					
45	26.2	1.60	28.1	1.40					
42	27.5	1.50	29.1	1.35					
39	28.6	1.45	30.0	1.35					
36	29.7	1.45	30.8	1.35					
33	30.7	1.40	31.5	1.30					
30	31.6	1.35	32.2	1.30					
27	32.4	1.35							
24	33.1	1.30							
21	33.6	1.30							
18	34.1	1.30							
17	34.3	1.30							
 危険 角度	[°]	16		29		48		65	
 標準 フック	[ton]	5.6							
 フック 質量	[kg]	120							
 巻掛 本数	[本]	1							













通常伸縮 カウンタウエイト付	ブーム  13.8m	ジブ  7.6m	アウトリガ  7.6m	作業範囲 
-------------------	---	--	--	---

 [m]	24.0								
	5		25		45		60		
	 [m]	 [ton]	 [m]	 [ton]	 [m]	 [ton]	 [m]	 [ton]	
84	3.7	2.80	8.2	2.65	11.3	1.55	12.8	1.00	
81	5.8	2.80	10.3	2.50	13.0	1.50	14.3	1.00	
78	7.8	2.75	12.1	2.35	14.7	1.45	15.8	1.00	
75	9.8	2.75	13.9	2.20	16.3	1.45	17.1	1.00	
72	11.8	2.70	15.5	2.05	17.8	1.40	18.5	1.00	
69	13.7	2.65	17.1	1.95	19.2	1.35	19.8	1.00	
66	15.5	2.50	18.6	1.85	20.6	1.35	21.0	1.00	
63	17.2	2.25	20.1	1.75	21.9	1.30			
60	18.9	2.10	21.6	1.65	23.2	1.30			
57	20.5	1.95	23.0	1.60	24.3	1.30			
54	22.1	1.80	24.4	1.55	25.4	1.25			
51	23.5	1.75	25.7	1.50	26.4	1.25			
49	24.5	1.65	26.5	1.45	27.1	1.25			
48	24.9	1.65	26.9	1.45					
45	26.2	1.60	28.1	1.40					
42	27.5	1.50	29.1	1.35					
39	28.6	1.45	30.0	1.35					
36	29.7	1.45	30.8	1.35					
33	30.7	1.40	31.5	1.30					
30	31.6	1.35	32.2	1.30					
27	32.4	1.35							
24	33.1	1.30							
21	33.6	1.25							
18	34.1	1.20							
17	34.3	1.20							
 危険 角度	[°]	16		29		48		65	
 標準 フック	[ton]	5.6							
 フック 質量	[kg]	120							
 巻掛 本数	[本]	1							





通常伸縮 カウンタウエイト付	ブーム 	ジブ  13.8m	アウトリガ  7.2m	作業範囲 
-------------------	--	---	--	---













 [m]	24.0								
	5		25		45		60		
	 [m]	 [ton]	 [m]	 [ton]	 [m]	 [ton]	 [m]	 [ton]	
84	3.7	2.80	8.2	2.65	11.3	1.55	12.8	1.00	
81	5.8	2.80	10.3	2.50	13.0	1.50	14.3	1.00	
78	7.8	2.75	12.1	2.35	14.7	1.45	15.8	1.00	
75	9.8	2.75	13.9	2.20	16.3	1.45	17.1	1.00	
72	11.8	2.70	15.5	2.05	17.8	1.40	18.5	1.00	
69	13.7	2.65	17.1	1.95	19.2	1.35	19.8	1.00	
66	15.5	2.50	18.6	1.85	20.6	1.35	21.0	1.00	
63	17.2	2.25	20.1	1.75	21.9	1.30			
60	18.9	2.10	21.6	1.65	23.2	1.30			
57	20.5	1.95	23.0	1.60	24.3	1.30			
54	22.1	1.80	24.4	1.55	25.4	1.25			
51	23.5	1.75	25.7	1.50	26.4	1.25			
49	24.5	1.65	26.5	1.45	27.1	1.25			
48	24.9	1.65	26.9	1.45					
45	26.2	1.60	28.1	1.40					
42	27.5	1.50	29.1	1.35					
39	28.6	1.45	30.0	1.35					
36	29.7	1.45	30.8	1.35					
33	30.7	1.40	31.5	1.30					
30	31.6	1.35	32.2	1.30					
27	32.4	1.30							
24	33.1	1.15							
21	33.6	1.05							
18	34.1	0.95							
17	34.3	0.90							
 危険 角度	[°]	16		29		48		65	
 標準 フック	[ton]	5.6							
 フック 質量	[kg]	120							
 巻掛 本数	[本]	1							





通常伸縮 カウンタウエイト付	ブーム  13.8m	ジブ  13.8m	アウトリガ  6.5m	作業範囲 
-------------------	---	---	--	---













 [m]	24.0								
	5		25		45		60		
	 [m]	 [ton]	 [m]	 [ton]	 [m]	 [ton]	 [m]	 [ton]	
84	3.7	2.80	8.2	2.65	11.3	1.55	12.8	1.00	
81	5.8	2.80	10.3	2.50	13.0	1.50	14.3	1.00	
78	7.8	2.75	12.1	2.35	14.7	1.45	15.8	1.00	
75	9.8	2.75	13.9	2.20	16.3	1.45	17.1	1.00	
72	11.8	2.70	15.5	2.05	17.8	1.40	18.5	1.00	
69	13.7	2.65	17.1	1.95	19.2	1.35	19.8	1.00	
66	15.5	2.50	18.6	1.85	20.6	1.35	21.0	1.00	
63	17.2	2.25	20.1	1.75	21.9	1.30			
60	18.9	2.10	21.6	1.65	23.2	1.30			
57	20.5	1.95	23.0	1.60	24.3	1.30			
54	22.1	1.80	24.4	1.55	25.4	1.25			
51	23.5	1.75	25.7	1.50	26.4	1.25			
49	24.5	1.65	26.5	1.45	27.1	1.25			
48	24.9	1.65	26.9	1.45					
45	26.2	1.60	28.1	1.40					
42	27.5	1.50	29.1	1.35					
39	28.6	1.45	30.0	1.35					
36	29.7	1.35	30.8	1.30					
33	30.6	1.20	31.5	1.15					
30	31.5	1.00	32.1	0.95					
27	32.3	0.80							
24	33.0	0.70							
21	33.6	0.60							
18	34.1	0.50							
17	34.3	0.45							
 危険 角度	[°]	16		29		48		65	
 標準 フック	[ton]	5.6							
 フック 質量	[kg]	120							
 巻掛 本数	[本]	1							



















通常伸縮 カウンタウエイト付	ブーム 	ジブ  13.8m	アウトリガ  5.4m	作業範囲 
-------------------	--	---	--	---





 [m]	24.0								
	5		25		45		60		
	 [m]	 [ton]	 [m]	 [ton]	 [m]	 [ton]	 [m]	 [ton]	
84	3.7	2.80	8.2	2.65	11.3	1.55	12.8	1.00	
81	5.8	2.80	10.3	2.50	13.0	1.50	14.3	1.00	
78	7.8	2.75	12.1	2.35	14.7	1.45	15.8	1.00	
75	9.8	2.75	13.9	2.20	16.3	1.45	17.1	1.00	
72	11.8	2.70	15.5	2.05	17.8	1.40	18.5	1.00	
69	13.7	2.65	17.1	1.95	19.2	1.35	19.8	1.00	
66	15.5	2.50	18.6	1.85	20.6	1.35	21.0	1.00	
63	17.2	2.25	20.1	1.75	21.9	1.30			
60	18.9	2.10	21.6	1.65	23.2	1.30			
57	20.5	1.95	23.0	1.60	24.3	1.30			
54	22.1	1.80	24.4	1.55	25.4	1.25			
51	23.5	1.75	25.7	1.50	26.4	1.25			
49	24.5	1.65	26.5	1.45	27.1	1.25			
48	24.9	1.55	26.9	1.40					
45	26.2	1.30	28.0	1.20					
42	27.4	1.00	29.0	0.95					
39	28.5	0.80	29.9	0.75					
36	29.5	0.55	30.8	0.55					
34	30.2	0.45	31.2	0.45					
 危険 角度	[°]	33		33		48		65	
 標準 フック	[ton]	5.6							
 フック 質量	[kg]	120							
 巻掛 本数	[本]	1							













通常伸縮 カウンタウエイト付	ブーム 	ジブ  13.8m	アウトリガ  4.3m	作業範囲 
-------------------	--	---	--	---





 [m]	24.0								
	5		25		45		60		
	 [m]	 [ton]	 [m]	 [ton]	 [m]	 [ton]	 [m]	 [ton]	
84	3.7	2.80	8.2	2.65	11.3	1.55	12.8	1.00	
81	5.8	2.80	10.3	2.50	13.0	1.50	14.3	1.00	
78	7.8	2.75	12.1	2.35	14.7	1.45	15.8	1.00	
75	9.8	2.75	13.9	2.20	16.3	1.45	17.1	1.00	
72	11.8	2.70	15.5	2.05	17.8	1.40	18.5	1.00	
69	13.7	2.65	17.1	1.95	19.2	1.35	19.8	1.00	
66	15.5	2.50	18.6	1.85	20.6	1.35	21.0	1.00	
63	17.2	2.25	20.1	1.75	21.9	1.30			
60	18.9	2.10	21.6	1.65	23.2	1.30			
57	20.4	1.75	23.0	1.50	24.3	1.25			
54	21.9	1.40	24.3	1.20	25.4	1.15			
51	23.3	1.05	25.6	0.90	26.4	0.90			
49	24.2	0.80	26.4	0.70	27.1	0.70			
48	24.7	0.70	26.8	0.60					
47	25.1	0.60	27.2	0.50					
 危険 角度	[°]	46		46		48		65	
 標準 フック	[ton]	5.6							
 フック 質量	[kg]	120							
 巻掛 本数	[本]	1							













通常伸縮 カウンタウエイト付	ブーム 	ジブ  18.0m	アウトリガ  前方	作業範囲 
-------------------	--	---	--	---





 [m]	24.0								
	5		25		45		60		
	 [m]	 [ton]	 [m]	 [ton]	 [m]	 [ton]	 [m]	 [ton]	
84	4.6	1.80	10.4	1.00	14.7	0.70	16.7	0.55	
81	6.9	1.80	12.5	1.00	16.6	0.70	18.3	0.55	
78	9.3	1.75	14.5	0.95	18.3	0.65	19.8	0.55	
75	11.5	1.65	16.5	0.95	20.0	0.65	21.2	0.55	
72	13.6	1.45	18.4	0.85	21.6	0.60	22.6	0.55	
69	15.7	1.30	20.3	0.80	23.1	0.60	23.9	0.55	
66	17.7	1.20	22.0	0.75	24.5	0.60	25.1	0.55	
64	19.0	1.10	23.1	0.75	25.5	0.55	25.9	0.55	
63	19.6	1.05	23.7	0.70	25.9	0.55			
60	21.4	0.95	25.3	0.70	27.2	0.55			
57	23.2	0.85	26.8	0.65	28.4	0.55			
54	24.9	0.80	28.2	0.60	29.6	0.55			
51	26.5	0.75	29.6	0.60	30.6	0.55			
49	27.6	0.70	30.4	0.60	31.2	0.55			
48	28.1	0.70	30.8	0.60					
45	29.6	0.65	32.0	0.60					
42	31.0	0.60	33.1	0.55					
39	32.3	0.60	34.0	0.55					
36	33.4	0.55	34.9	0.55					
33	34.5	0.55	35.7	0.55					
31	35.2	0.55	36.1	0.55					
30	35.5	0.55							
27	36.3	0.50							
24	37.1	0.50							
21	37.7	0.50							
18	38.3	0.50							
 危険 角度	[°]	17		30		48		63	
 標準 フック	[ton]	5.6							
 フック 質量	[kg]	120							
 巻掛 本数	[本]	1							













通常伸縮 カウンタウエイト付	ブーム 	ジブ  18.0m	アウトリガ  7.6m	作業範囲 
-------------------	--	---	--	---



 [m]	24.0								
	5		25		45		60		
	 [m]	 [ton]	 [m]	 [ton]	 [m]	 [ton]	 [m]	 [ton]	
84	4.6	1.80	10.4	1.00	14.7	0.70	16.7	0.55	
81	6.9	1.80	12.5	1.00	16.6	0.70	18.3	0.55	
78	9.3	1.75	14.5	0.95	18.3	0.65	19.8	0.55	
75	11.5	1.65	16.5	0.95	20.0	0.65	21.2	0.55	
72	13.6	1.45	18.4	0.85	21.6	0.60	22.6	0.55	
69	15.7	1.30	20.3	0.80	23.1	0.60	23.9	0.55	
66	17.7	1.20	22.0	0.75	24.5	0.60	25.1	0.55	
64	19.0	1.10	23.1	0.75	25.5	0.55	25.9	0.55	
63	19.6	1.05	23.7	0.70	25.9	0.55			
60	21.4	0.95	25.3	0.70	27.2	0.55			
57	23.2	0.85	26.8	0.65	28.4	0.55			
54	24.9	0.80	28.2	0.60	29.6	0.55			
51	26.5	0.75	29.6	0.60	30.6	0.55			
49	27.6	0.70	30.4	0.60	31.2	0.55			
48	28.1	0.70	30.8	0.60					
45	29.6	0.65	32.0	0.60					
42	31.0	0.60	33.1	0.55					
39	32.3	0.60	34.0	0.55					
36	33.4	0.55	34.9	0.55					
33	34.5	0.55	35.7	0.55					
31	35.2	0.55	36.1	0.55					
30	35.5	0.55							
27	36.3	0.50							
24	37.1	0.50							
21	37.7	0.50							
18	38.3	0.50							
 危険 角度	[°]	17		30		48		63	
 標準 フック	[ton]	5.6							
 フック 質量	[kg]	120							
 巻掛 本数	[本]	1							













通常伸縮 カウンタウエイト付	ブーム 	ジブ  18.0m	アウトリガ  7.2m	作業範囲 
-------------------	--	---	--	---





 [m]	24.0								
	5		25		45		60		
	 [m]	 [ton]	 [m]	 [ton]	 [m]	 [ton]	 [m]	 [ton]	
84	4.6	1.80	10.4	1.00	14.7	0.70	16.7	0.55	
81	6.9	1.80	12.5	1.00	16.6	0.70	18.3	0.55	
78	9.3	1.75	14.5	0.95	18.3	0.65	19.8	0.55	
75	11.5	1.65	16.5	0.95	20.0	0.65	21.2	0.55	
72	13.6	1.45	18.4	0.85	21.6	0.60	22.6	0.55	
69	15.7	1.30	20.3	0.80	23.1	0.60	23.9	0.55	
66	17.7	1.20	22.0	0.75	24.5	0.60	25.1	0.55	
64	19.0	1.10	23.1	0.75	25.5	0.55	25.9	0.55	
63	19.6	1.05	23.7	0.70	25.9	0.55			
60	21.4	0.95	25.3	0.70	27.2	0.55			
57	23.2	0.85	26.8	0.65	28.4	0.55			
54	24.9	0.80	28.2	0.60	29.6	0.55			
51	26.5	0.75	29.6	0.60	30.6	0.55			
49	27.6	0.70	30.4	0.60	31.2	0.55			
48	28.1	0.70	30.8	0.60					
45	29.6	0.65	32.0	0.60					
42	31.0	0.60	33.1	0.55					
39	32.3	0.60	34.0	0.55					
36	33.4	0.55	34.9	0.55					
33	34.5	0.55	35.7	0.55					
31	35.2	0.55	36.1	0.55					
30	35.5	0.55							
27	36.3	0.50							
24	37.1	0.50							
21	37.7	0.50							
18	38.3	0.50							
 危険 角度	[°]	17		30		48		63	
 標準 フック	[ton]	5.6							
 フック 質量	[kg]	120							
 巻掛 本数	[本]	1							













通常伸縮 カウンタウエイト付	ブーム 	ジブ  18.0m	アウトリガ  6.5m	作業範囲 
-------------------	--	---	--	---





 [m]	24.0								
	5		25		45		60		
	 [m]	 [ton]	 [m]	 [ton]	 [m]	 [ton]	 [m]	 [ton]	
84	4.6	1.80	10.4	1.00	14.7	0.70	16.7	0.55	
81	6.9	1.80	12.5	1.00	16.6	0.70	18.3	0.55	
78	9.3	1.75	14.5	0.95	18.3	0.65	19.8	0.55	
75	11.5	1.65	16.5	0.95	20.0	0.65	21.2	0.55	
72	13.6	1.45	18.4	0.85	21.6	0.60	22.6	0.55	
69	15.7	1.30	20.3	0.80	23.1	0.60	23.9	0.55	
66	17.7	1.20	22.0	0.75	24.5	0.60	25.1	0.55	
64	19.0	1.10	23.1	0.75	25.5	0.55	25.9	0.55	
63	19.6	1.05	23.7	0.70	25.9	0.55			
60	21.4	0.95	25.3	0.70	27.2	0.55			
57	23.2	0.85	26.8	0.65	28.4	0.55			
54	24.9	0.80	28.2	0.60	29.6	0.55			
51	26.5	0.75	29.6	0.60	30.6	0.55			
49	27.6	0.70	30.4	0.60	31.2	0.55			
48	28.1	0.70	30.8	0.60					
45	29.6	0.65	32.0	0.60					
42	31.0	0.60	33.1	0.55					
39	32.3	0.60	34.0	0.55					
36	33.4	0.55	34.9	0.55					
33	34.5	0.55	35.7	0.55					
31	35.2	0.55	36.1	0.55					
30	35.5	0.55							
27	36.3	0.50							
24	37.1	0.50							
23	37.3	0.50							
 危険 角度	[°]	22		30		48		63	
 標準 フック	[ton]	5.6							
 フック 質量	[kg]	120							
 巻掛 本数	[本]	1							













通常伸縮 カウンタウエイト付	ブーム 	ジブ  18.0m	アウトリガ  5.4m	作業範囲 
-------------------	--	---	--	---

 [m]	24.0								
	5		25		45		60		
	 [m]	 [ton]	 [m]	 [ton]	 [m]	 [ton]	 [m]	 [ton]	
84	4.6	1.80	10.4	1.00	14.7	0.70	16.7	0.55	
81	6.9	1.80	12.5	1.00	16.6	0.70	18.3	0.55	
78	9.3	1.75	14.5	0.95	18.3	0.65	19.8	0.55	
75	11.5	1.65	16.5	0.95	20.0	0.65	21.2	0.55	
72	13.6	1.45	18.4	0.85	21.6	0.60	22.6	0.55	
69	15.7	1.30	20.3	0.80	23.1	0.60	23.9	0.55	
66	17.7	1.20	22.0	0.75	24.5	0.60	25.1	0.55	
64	19.0	1.10	23.1	0.75	25.5	0.55	25.9	0.55	
63	19.6	1.05	23.7	0.70	25.9	0.55			
60	21.4	0.95	25.3	0.70	27.2	0.55			
57	23.2	0.85	26.8	0.65	28.4	0.55			
54	24.9	0.80	28.2	0.60	29.6	0.55			
51	26.5	0.75	29.6	0.60	30.6	0.55			
49	27.6	0.70	30.4	0.60	31.2	0.55			
48	28.1	0.70	30.8	0.60					
45	29.6	0.65	32.0	0.60					
42	31.0	0.60	33.1	0.55					
39	32.3	0.55	34.0	0.55					
38	32.7	0.50	34.3	0.50					
36	33.4	0.40							
 危険 角度	[°]	35		37		48		63	
 標準 フック	[ton]	5.6							
 フック 質量	[kg]	120							
 巻掛 本数	[本]	1							





通常伸縮 カウンタウエイト付	ブーム 	ジブ  18.0m	アウトリガ  4.3m	作業範囲 
-------------------	--	---	--	---















 [m]	24.0							
	5		25		45		60	
	 [m]	 [ton]	 [m]	 [ton]	 [m]	 [ton]	 [m]	 [ton]
84	4.6	1.80	10.4	1.00	14.7	0.70	16.7	0.55
81	6.9	1.80	12.5	1.00	16.6	0.70	18.3	0.55
78	9.3	1.75	14.5	0.95	18.3	0.65	19.8	0.55
75	11.5	1.65	16.5	0.95	20.0	0.65	21.2	0.55
72	13.6	1.45	18.4	0.85	21.6	0.60	22.6	0.55
69	15.7	1.30	20.3	0.80	23.1	0.60	23.9	0.55
66	17.7	1.20	22.0	0.75	24.5	0.60	25.1	0.55
64	19.0	1.10	23.1	0.75	25.5	0.55	25.9	0.55
63	19.6	1.05	23.7	0.70	25.9	0.55		
60	21.4	0.95	25.3	0.70	27.2	0.55		
57	23.2	0.85	26.8	0.65	28.4	0.55		
54	24.9	0.80	28.2	0.60	29.6	0.55		
51	26.5	0.70	29.6	0.60	30.6	0.55		
49	27.6	0.60	30.4	0.50	31.2	0.50		
48	28.1	0.50						
47	28.6	0.40						
 危険 角度	[°]	46	48	48	48	48	63	
 標準 フック	[ton]	5.6						
 フック 質量	[kg]	120						
 巻掛 本数	[本]	1						





通常伸縮 カウンタウエイト付	ブーム 	ジブ  13.8m	アウトリガ  前方	作業範囲 
-------------------	--	---	--	---















 [m]	45.0								
	5		25		45		60		
	 [m]	 [ton]	 [m]	 [ton]	 [m]	 [ton]	 [m]	 [ton]	
84	7.4	2.80	12.4	2.60	15.0	1.50	16.0	1.00	
81	11.4	2.75	15.7	2.40	17.9	1.45	18.8	1.00	
78	15.0	2.70	18.9	2.20	20.8	1.40	21.5	1.00	
75	18.4	2.70	21.8	2.05	23.7	1.35	24.1	1.00	
72	21.5	2.65	24.7	1.90	26.5	1.35	26.6	1.00	
69	24.6	2.45	27.4	1.80	29.1	1.30	29.0	1.00	
66	27.4	2.15	30.0	1.70	31.5	1.30	31.2	1.00	
64	29.2	1.95	31.7	1.55	33.0	1.30	32.7	1.00	
63	30.1	1.85	32.6	1.50	33.7	1.25			
60	32.6	1.60	34.8	1.35	35.8	1.25			
57	35.0	1.40	37.0	1.20	37.8	1.15			
54	37.4	1.25	39.1	1.10	39.7	1.05			
51	39.6	1.10	41.2	1.00	41.5	0.95			
49	41.0	1.05	42.6	0.90	42.6	0.90			
48	41.7	1.00	43.2	0.90					
45	43.6	0.90	45.0	0.80					
42	45.4	0.80	46.6	0.75					
39	47.1	0.70	48.0	0.70					
36	48.6	0.65	49.3	0.60					
33	50.0	0.55	50.4	0.55					
30	51.3	0.45	51.4	0.45					
29	51.7	0.40	51.7	0.40					
 危険 角度	[°]	28		28		48		63	
 標準 フック	[ton]	5.6							
 フック 質量	[kg]	120							
 巻掛 本数	[本]	1							





















通常伸縮 カウンタウエイト付	ブーム 	ジブ  13.8m	アウトリガ  7.6m	作業範囲 
-------------------	--	---	--	---





 [m]	45.0								
	5		25		45		60		
 [°]									
	[m]	[ton]	[m]	[ton]	[m]	[ton]	[m]	[ton]	
84	7.4	2.80	12.4	2.60	15.0	1.50	16.0	1.00	
81	11.4	2.75	15.7	2.40	17.9	1.45	18.8	1.00	
78	15.0	2.70	18.9	2.20	20.8	1.40	21.5	1.00	
75	18.4	2.70	21.8	2.05	23.7	1.35	24.1	1.00	
72	21.5	2.65	24.7	1.90	26.5	1.35	26.6	1.00	
69	24.6	2.45	27.4	1.80	29.1	1.30	29.0	1.00	
66	27.4	2.15	30.0	1.70	31.5	1.30	31.2	1.00	
64	29.2	1.95	31.7	1.55	33.0	1.30	32.7	1.00	
63	30.1	1.85	32.6	1.50	33.7	1.25			
60	32.6	1.60	34.8	1.35	35.8	1.25			
57	35.0	1.40	37.0	1.20	37.8	1.15			
54	37.4	1.05	39.1	1.05	39.7	1.00			
51	39.2	0.75	41.1	0.75	41.3	0.75			
49	40.4	0.60	42.3	0.55	42.4	0.55			
48	41.0	0.55	42.9	0.50					
47	41.6	0.45	43.4	0.45					
46	42.2	0.40							
 危険 角度	[°]	45		46		48		63	
 標準 フック	[ton]	5.6							
 フック 質量	[kg]	120							
 巻掛 本数	[本]	1							















通常伸縮 カウンタウエイト付	ブーム 	ジブ  13.8m	アウトリガ  7.2m	作業範囲 
-------------------	--	---	--	---





 [m]	45.0								
 [°]	5		25		45		60		
 [°]									
	[m]	[ton]	[m]	[ton]	[m]	[ton]	[m]	[ton]	
84	7.4	2.80	12.4	2.60	15.0	1.50	16.0	1.00	
81	11.4	2.75	15.7	2.40	17.9	1.45	18.8	1.00	
78	15.0	2.70	18.9	2.20	20.8	1.40	21.5	1.00	
75	18.4	2.70	21.8	2.05	23.7	1.35	24.1	1.00	
72	21.5	2.65	24.7	1.90	26.5	1.35	26.6	1.00	
69	24.6	2.45	27.4	1.80	29.1	1.30	29.0	1.00	
66	27.4	2.15	30.0	1.70	31.5	1.30	31.2	1.00	
64	29.2	1.95	31.7	1.55	33.0	1.30	32.7	1.00	
63	30.1	1.85	32.6	1.50	33.7	1.25			
60	32.6	1.60	34.8	1.35	35.8	1.25			
57	35.0	1.20	37.0	1.15	37.8	1.10			
54	36.8	0.90	39.0	0.80	39.5	0.80			
51	38.9	0.60	40.9	0.55	41.2	0.55			
49	40.2	0.40	42.0	0.40	42.3	0.40			
 危険 角度 標準 フック	[°]	48		48		48		63	
 フック 質量	[kg]	120							
 巻掛 本数	[本]	1							















通常伸縮 カウンタウエイト付	ブーム 	ジブ  13.8m	アウトリガ  6.5m	作業範囲 
-------------------	--	---	--	---





 [m]	45.0								
 [°]	5		25		45		60		
 [°]									
	[m]	[ton]	[m]	[ton]	[m]	[ton]	[m]	[ton]	
84	7.4	2.80	12.4	2.60	15.0	1.50	16.0	1.00	
81	11.4	2.75	15.7	2.40	17.9	1.45	18.8	1.00	
78	15.0	2.70	18.9	2.20	20.8	1.40	21.5	1.00	
75	18.4	2.70	21.8	2.05	23.7	1.35	24.1	1.00	
72	21.5	2.65	24.7	1.90	26.5	1.35	26.6	1.00	
69	24.6	2.45	27.4	1.80	29.1	1.30	29.0	1.00	
66	27.4	2.05	30.0	1.70	31.5	1.30	31.2	1.00	
64	29.2	1.75	31.7	1.55	33.0	1.30	32.7	1.00	
63	30.1	1.55	32.6	1.45	33.7	1.25			
60	32.0	1.25	34.6	1.10	35.8	1.10			
57	34.3	0.85	36.7	0.75	37.6	0.75			
55	35.7	0.65	38.6	0.50	38.8	0.50			
54	36.4	0.50							
 危険 角度	[°]	53		54		54		63	
 標準 フック	[ton]	5.6							
 フック 質量	[kg]	120							
 巻掛 本数	[本]	1							













通常伸縮 カウンタウエイト付	ブーム 	ジブ  13.8m	アウトリガ  5.4m	作業範囲 
-------------------	--	---	--	---





 [m]	45.0								
 [°]	5		25		45		60		
 [°]									
	[m]	[ton]	[m]	[ton]	[m]	[ton]	[m]	[ton]	
84	7.4	2.80	12.4	2.60	15.0	1.50	16.0	1.00	
81	11.4	2.75	15.7	2.40	17.9	1.45	18.8	1.00	
78	15.0	2.70	18.9	2.20	20.8	1.40	21.5	1.00	
75	18.4	2.70	21.8	2.05	23.7	1.35	24.1	1.00	
72	21.5	2.60	24.7	1.90	26.5	1.35	26.6	1.00	
69	24.6	1.90	27.4	1.65	29.1	1.30	29.0	1.00	
66	26.3	1.55	29.7	1.25	31.3	1.15	31.2	1.00	
64	28.0	1.25	31.3	1.00	32.7	0.90	32.7	0.90	
63	28.9	1.05	32.0	0.85	33.4	0.75			
62	29.8	0.85							
 危険 角度	[°]	61		62		62		63	
 標準 フック	[ton]	5.6							
 フック 質量	[kg]	120							
 巻掛 本数	[本]	1							















通常伸縮 カウンタウエイト付	ブーム 	ジブ  13.8m	アウトリガ  4.3m	作業範囲 
-------------------	--	---	--	---





 [m]	45.0								
 [°]	5		25		45		60		
 [°]									
	[m]	[ton]	[m]	[ton]	[m]	[ton]	[m]	[ton]	
84	7.4	2.80	12.4	2.60	15.0	1.50	16.0	1.00	
81	11.4	2.75	15.7	2.40	17.9	1.45	18.8	1.00	
78	15.0	2.70	18.9	2.20	20.8	1.40	21.5	1.00	
75	18.4	2.60	21.8	2.05	23.7	1.35	24.1	1.00	
72	20.8	1.90	24.4	1.50	26.5	1.30	26.6	1.00	
70	22.5	1.50	25.9	1.25	28.3	1.05	28.2	1.00	
69	23.3	1.35	26.6	1.10					
68	24.1	1.15							
 危険 角度	[°]	67		68		69		69	
 標準 フック	[ton]	5.6							
 フック 質量	[kg]	120							
 巻掛 本数	[本]	1							















通常伸縮 カウンタウエイト付	ブーム 	ジブ  18.0m	アウトリガ  前方	作業範囲 
-------------------	--	---	--	---





 [m]	45.0								
	5		25		45		60		
	 [m]	 [ton]	 [m]	 [ton]	 [m]	 [ton]	 [m]	 [ton]	
84	8.5	1.80	14.3	1.00	18.3	0.70	20.1	0.55	
81	12.5	1.75	17.9	1.00	21.5	0.65	23.0	0.55	
78	16.3	1.50	21.3	0.95	24.5	0.60	25.7	0.55	
75	19.7	1.30	24.5	0.85	27.4	0.60	28.3	0.55	
72	22.9	1.20	27.5	0.80	30.2	0.55	30.8	0.55	
69	26.0	1.10	30.3	0.75	32.8	0.55	33.1	0.55	
66	29.0	1.00	33.0	0.70	35.2	0.55	35.4	0.55	
65	30.0	1.00	33.9	0.70	36.0	0.55	36.1	0.55	
63	32.0	0.95	35.7	0.65	37.6	0.55			
60	35.1	0.85	38.4	0.65	39.8	0.50			
57	37.7	0.80	40.5	0.60	41.9	0.50			
54	40.4	0.70	42.8	0.60	43.8	0.50			
51	43.0	0.65	45.2	0.55	45.6	0.50			
49	44.6	0.65	46.6	0.55	46.7	0.50			
48	45.4	0.60	47.3	0.55					
45	47.5	0.60	49.2	0.55					
42	49.5	0.55	50.9	0.55					
39	51.3	0.55	52.4	0.55					
36	52.9	0.50	53.6	0.50					
33	54.3	0.45	54.7	0.45					
32	54.8	0.40	55.1	0.40					
 危険 角度	[°]	31		31		48		64	
 標準 フック	[ton]	5.6							
 フック 質量	[kg]	120							
 巻掛 本数	[本]	1							















通常伸縮 カウンタウエイト付	ブーム 	ジブ  18.0m	アウトリガ  7.6m	作業範囲 
-------------------	--	---	--	---





 [m]	45.0								
	5		25		45		60		
 [°]									
	[m]	[ton]	[m]	[ton]	[m]	[ton]	[m]	[ton]	
84	8.5	1.80	14.3	1.00	18.3	0.70	20.1	0.55	
81	12.5	1.75	17.9	1.00	21.5	0.65	23.0	0.55	
78	16.3	1.50	21.3	0.95	24.5	0.60	25.7	0.55	
75	19.7	1.30	24.5	0.85	27.4	0.60	28.3	0.55	
72	22.9	1.20	27.5	0.80	30.2	0.55	30.8	0.55	
69	26.0	1.10	30.3	0.75	32.8	0.55	33.1	0.55	
66	29.0	1.00	33.0	0.70	35.2	0.55	35.4	0.55	
65	30.0	1.00	33.9	0.70	36.0	0.55	36.1	0.55	
63	32.0	0.95	35.7	0.65	37.6	0.55			
60	35.1	0.85	38.4	0.65	39.8	0.50			
57	37.7	0.80	40.5	0.60	41.9	0.50			
54	40.4	0.70	42.8	0.60	43.8	0.50			
51	43.0	0.60	45.2	0.55	45.6	0.50			
49	44.6	0.40	46.6	0.40	46.7	0.40			
 危険 角度	[°]	48		48		48		64	
 標準 フック	[ton]	5.6							
 フック 質量	[kg]	120							
 巻掛 本数	[本]	1							















通常伸縮 カウンタウエイト付	ブーム 	ジブ  18.0m	アウトリガ  7.2m	作業範囲 
-------------------	--	---	--	---





 [m]	45.0								
 [°]	5		25		45		60		
 [°]									
	[m]	[ton]	[m]	[ton]	[m]	[ton]	[m]	[ton]	
84	8.5	1.80	14.3	1.00	18.3	0.70	20.1	0.55	
81	12.5	1.75	17.9	1.00	21.5	0.65	23.0	0.55	
78	16.3	1.50	21.3	0.95	24.5	0.60	25.7	0.55	
75	19.7	1.30	24.5	0.85	27.4	0.60	28.3	0.55	
72	22.9	1.20	27.5	0.80	30.2	0.55	30.8	0.55	
69	26.0	1.10	30.3	0.75	32.8	0.55	33.1	0.55	
66	29.0	1.00	33.0	0.70	35.2	0.55	35.4	0.55	
65	30.0	1.00	33.9	0.70	36.0	0.55	36.1	0.55	
63	32.0	0.95	35.7	0.65	37.6	0.55			
60	35.1	0.85	38.4	0.65	39.8	0.50			
57	37.7	0.80	40.5	0.60	41.9	0.50			
54	40.4	0.70	42.8	0.60	43.8	0.50			
52	42.1	0.45	44.4	0.45	45.0	0.45			
 危険 角度 標準 フック	[°]	51		51		51		64	
 フック 質量	[kg]	120							
 巻掛 本数	[本]	1							















通常伸縮 カウンタウエイト付	ブーム 	ジブ  18.0m	アウトリガ  6.5m	作業範囲 
-------------------	--	---	--	---

 [m]	45.0								
 [°]	5		25		45		60		
 [°]									
	[m]	[ton]	[m]	[ton]	[m]	[ton]	[m]	[ton]	
84	8.5	1.80	14.3	1.00	18.3	0.70	20.1	0.55	
81	12.5	1.75	17.9	1.00	21.5	0.65	23.0	0.55	
78	16.3	1.50	21.3	0.95	24.5	0.60	25.7	0.55	
75	19.7	1.30	24.5	0.85	27.4	0.60	28.3	0.55	
72	22.9	1.20	27.5	0.80	30.2	0.55	30.8	0.55	
69	26.0	1.10	30.3	0.75	32.8	0.55	33.1	0.55	
66	29.0	1.00	33.0	0.70	35.2	0.55	35.4	0.55	
65	30.0	1.00	33.9	0.70	36.0	0.55	36.1	0.55	
63	32.0	0.95	35.7	0.65	37.6	0.55			
60	35.1	0.85	38.4	0.65	39.8	0.50			
57	37.7	0.65	40.5	0.60	41.9	0.50			
56	38.6	0.50	41.3	0.50	42.6	0.50			
 危険 角度 標準 フック	[°]	55		55		55		64	
 フック 質量	[kg]	120							
 巻掛 本数	[本]	1							

通常伸縮 カウンタウエイト付	ブーム 	ジブ  18.0m	アウトリガ  5.4m	作業範囲 
-------------------	--	---	--	---

 [m]	45.0								
 [°]	5		25		45		60		
 [°]									
	[m]	[ton]	[m]	[ton]	[m]	[ton]	[m]	[ton]	
84	8.5	1.80	14.3	1.00	18.3	0.70	20.1	0.55	
81	12.5	1.75	17.9	1.00	21.5	0.65	23.0	0.55	
78	16.3	1.50	21.3	0.95	24.5	0.60	25.7	0.55	
75	19.7	1.30	24.5	0.85	27.4	0.60	28.3	0.55	
72	22.9	1.20	27.5	0.80	30.2	0.55	30.8	0.55	
69	26.0	1.10	30.3	0.75	32.8	0.55	33.1	0.55	
66	29.0	1.00	33.0	0.70	35.2	0.55	35.4	0.55	
65	30.0	1.00	33.9	0.70	36.0	0.55	36.1	0.55	
64	31.0	0.95	34.8	0.65	36.8	0.55			
 危険 角度	[°]	63		63		63		64	
 標準 フック	[ton]	5.6							
 フック 質量	[kg]	120							
 巻掛 本数	[本]	1							

通常伸縮 カウンタウエイト付	ブーム 	ジブ  18.0m	アウトリガ  4.3m	作業範囲 
-------------------	--	---	--	---

 [m]	45.0								
 [°]	5		25		45		60		
 [°]									
	[m]	[ton]	[m]	[ton]	[m]	[ton]	[m]	[ton]	
84	8.5	1.80	14.3	1.00	18.3	0.70	20.1	0.55	
81	12.5	1.75	17.9	1.00	21.5	0.65	23.0	0.55	
78	16.3	1.50	21.3	0.95	24.5	0.60	25.7	0.55	
75	19.7	1.30	24.5	0.85	27.4	0.60	28.3	0.55	
72	22.9	1.20	27.5	0.80	30.2	0.55	30.8	0.55	
71	23.9	1.15	28.4	0.75	31.0	0.55	31.6	0.55	
70	25.0	1.10							
 危険 角度	[°]	69		70		70		70	
 標準 フック	[ton]	5.6							
 フック 質量	[kg]	120							
 巻掛 本数	[本]	1							

# ■最小通路軌跡図

4輪ステアリングで右折する場合

● 60°

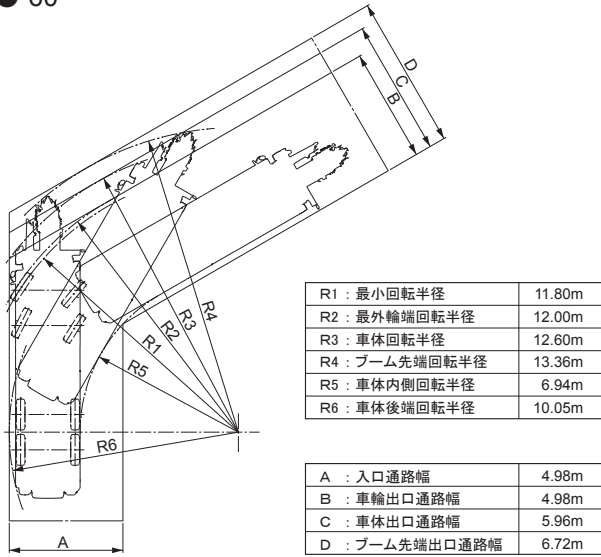

8輪ステアリングで右折する場合 (構内移動)

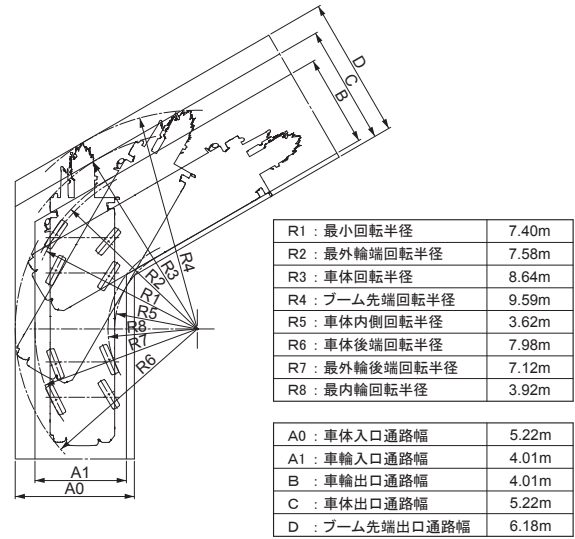

● 90°

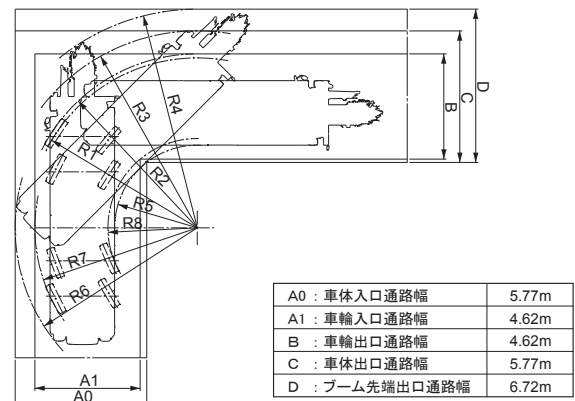
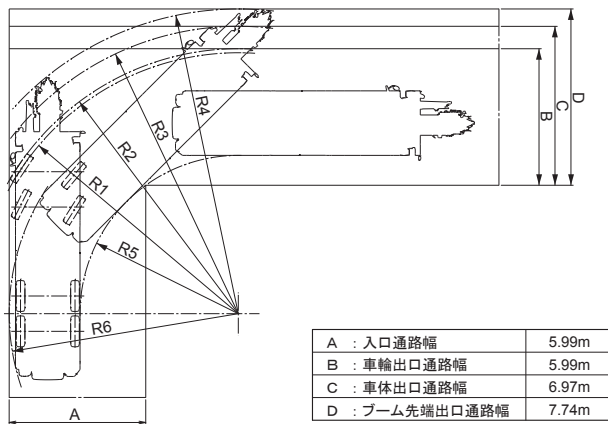

● 120°

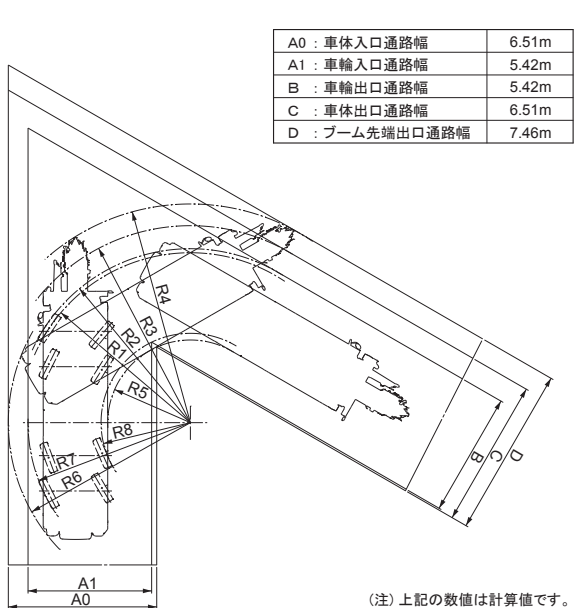
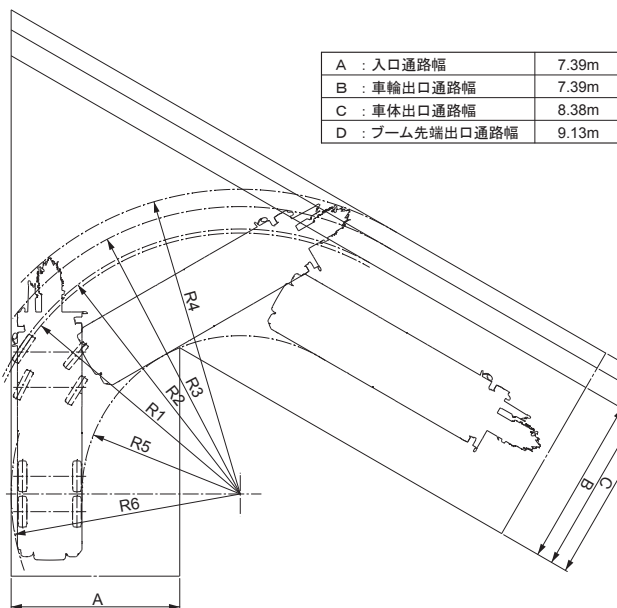

(注) 上記の数値は計算値です。



■全体図

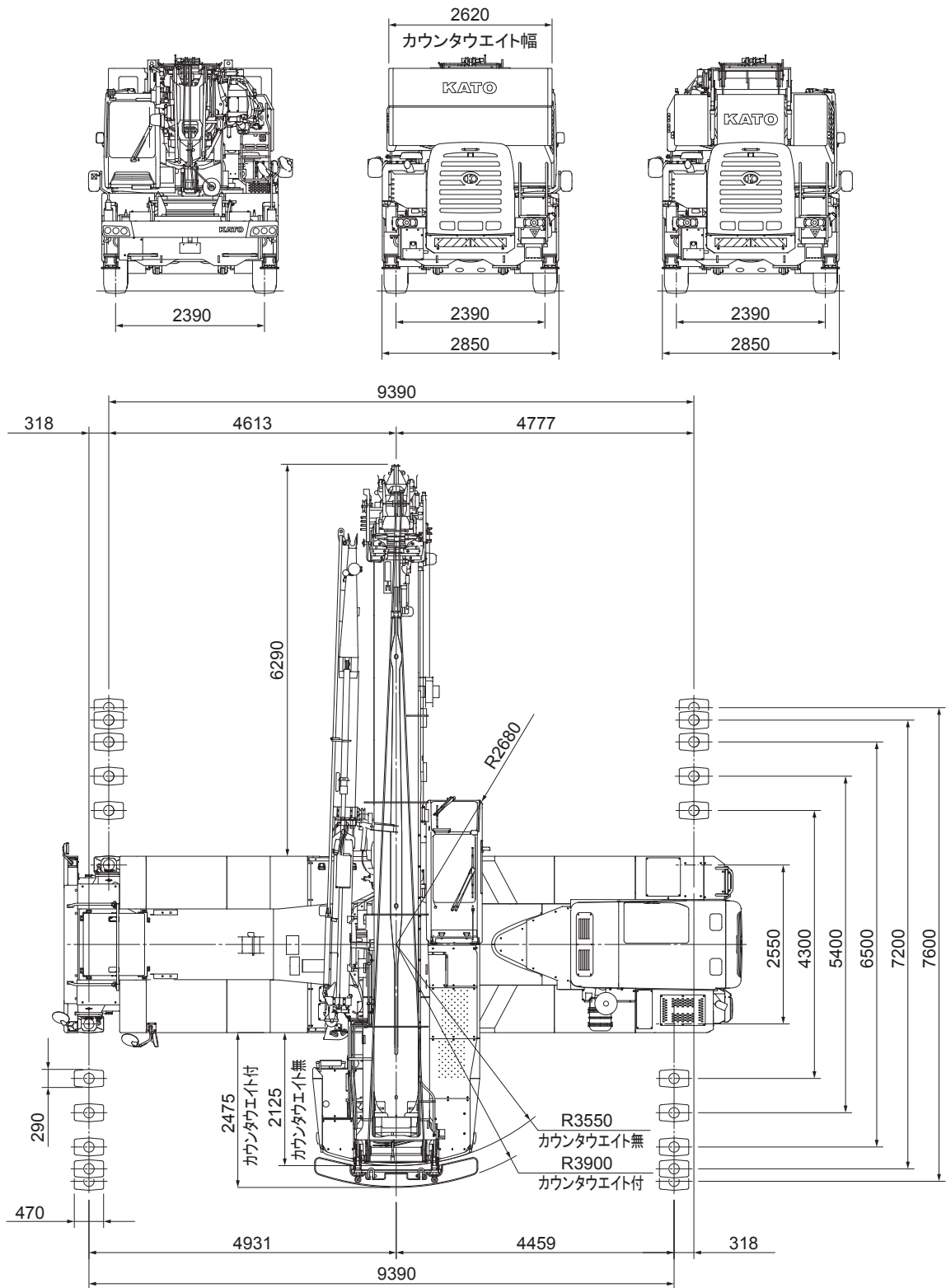

縮尺:  $\frac{1}{100}$  単位 (mm)

■全体図

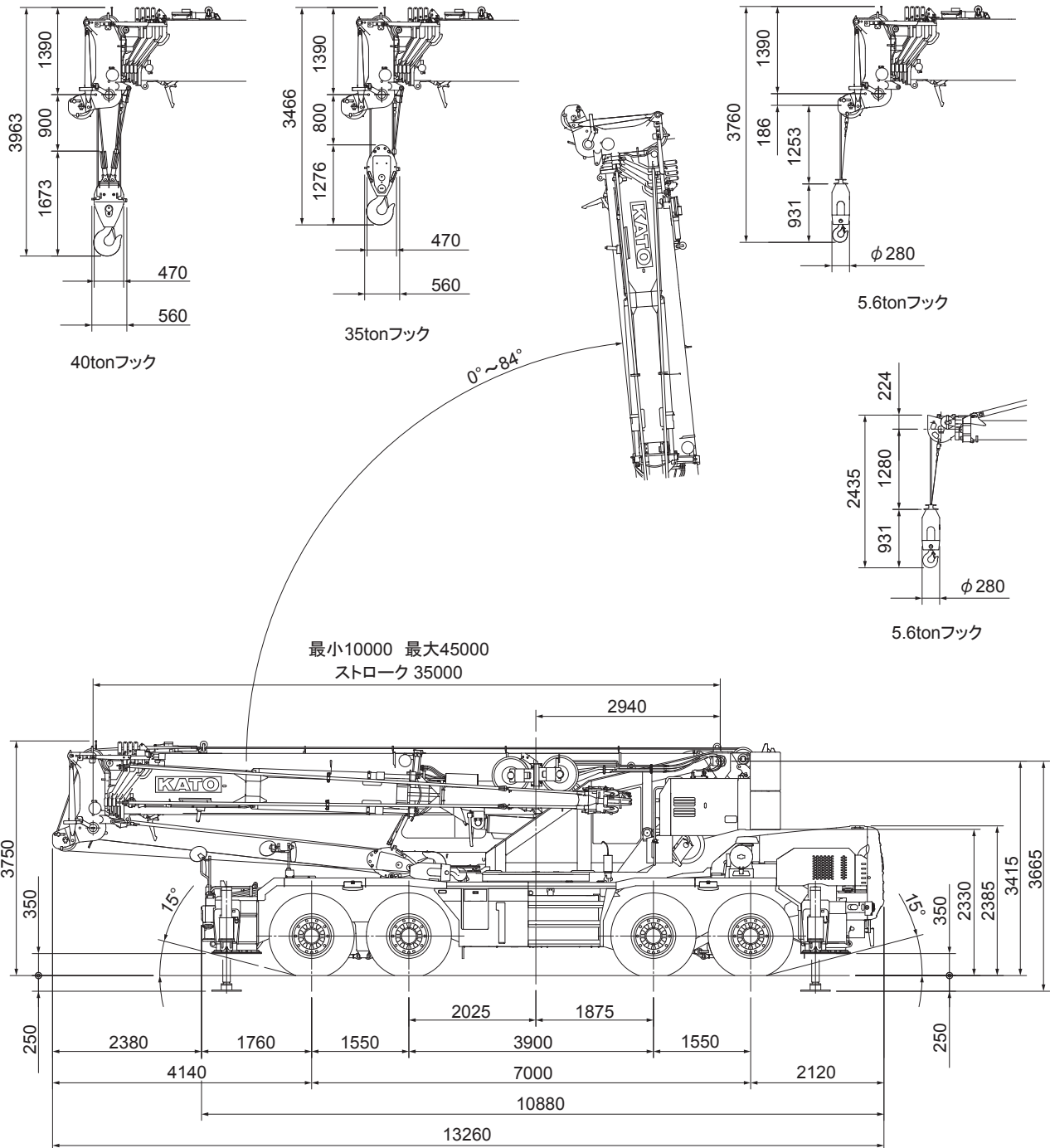

ランブブレークオーバーアングル :  $30^\circ$   
 サスペンションロック時全高より :  $-85\text{mm}$   
 (サスペンションシリンダー最縮小)

縮尺 :  $\frac{1}{100}$  単位 (mm)

※本カタログに記載されております性能ならびに仕様は、改良などによりお届けいたします製品と異なる場合がありますので、あらかじめご了承ください。

お問い合わせは…

**KATO** 株式会社 **加藤製作所**

本 社／〒140-0011 東京都品川区東大井1丁目9番37号

☎ 03 (3458) 1111番 (大代表)

ホームページアドレス <http://www.kato-works.co.jp>

**C05021**

3.2020-6000 (TI) 1